

PRODUCT SPECIFICATIONS

Product Type : LED Flexible Strip Light

Special Color : Yes. On Request

Product Name : LED Strip 6w/mtr

IP Rating: IP20 / IP65

Product Code : UHLS-2835-60-6W

Installation: 3M Adhesive

Wattage : 06W/M

Lumens : 24-26LM

CCT : 3000K / 4000K / 6000K

PCB Width: 10mm

Voltage : 12V

Nos. of LED / Mtr : 60

External SMPS Driver Required

DRIVER OPTIONS



SPECIAL ADDITIONAL FEATURES

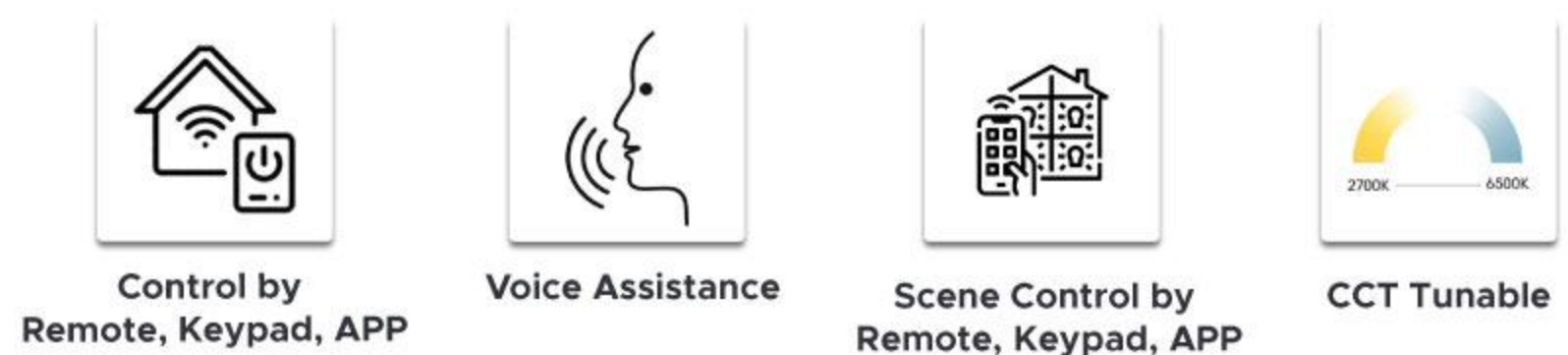

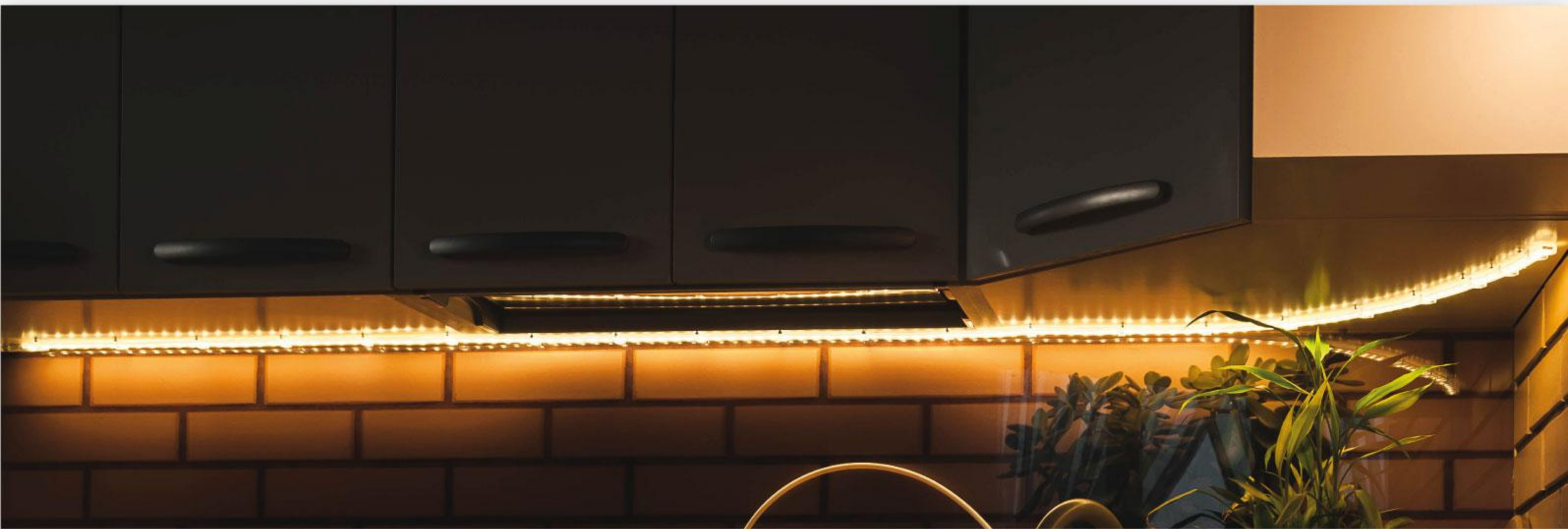

PRODUCT SPECIFICATIONS

Product Type : LED Flexible Strip Light

Special Color : No

Product Name : LED Strip 6w/mtr Scut

IP Rating: 20 / 65

Product Code : UHLS-2835-60-SCUT-6W

Installation : 3M Adhesive

Wattage : 6W

Lumens : 8-10LM

CCT : 3000K / 4000K

PCB : 8mm

Voltage : 12V / 24V

Nos. of LED / Mtr : 60

External SMPS Driver Required

DRIVER OPTIONS



SPECIAL ADDITIONAL FEATURES

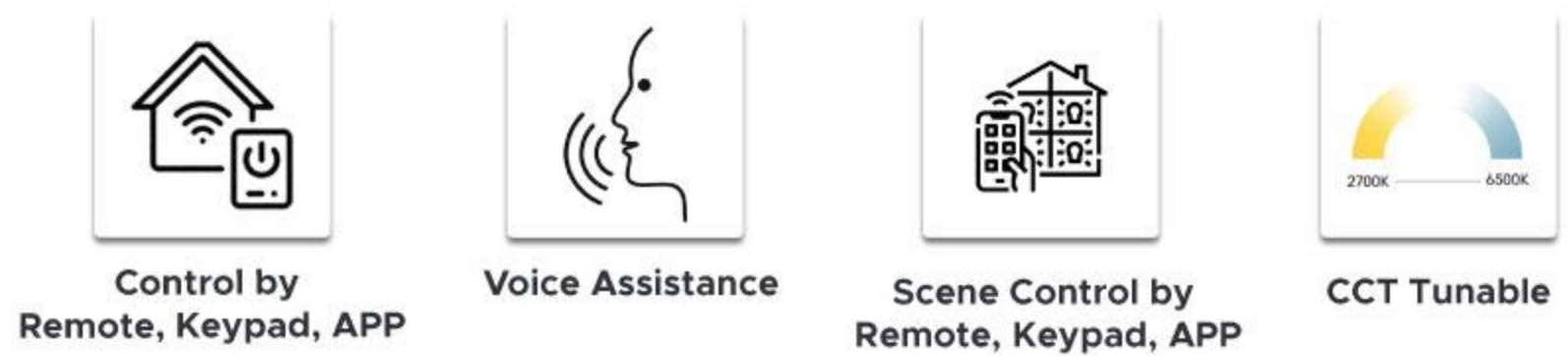



PRODUCT SPECIFICATIONS

Product Type : LED Flexible Strip Light

Product Name : Led Strip 12w/mtr

Product Code : UHLS-2835-120-12W

Wattage : 12W

CCT : 2500K / 2700K / 3000K / 4000K

Voltage : 12V /24V

External SMPS Driver Required

Special Color : Yes. On Request

IP Rating: IP20 /65

Installation : 3M Adhesive

Lumens : 8-10LM / 24-26LM

PCB : 8mm

Nos. of LED / Mtr : 120

DRIVER OPTIONS

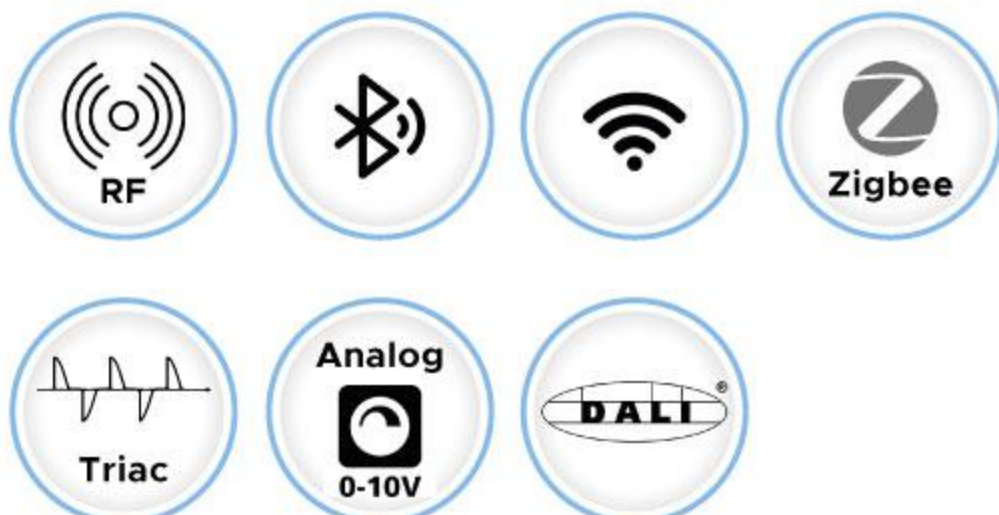

SPECIAL ADDITIONAL FEATURES

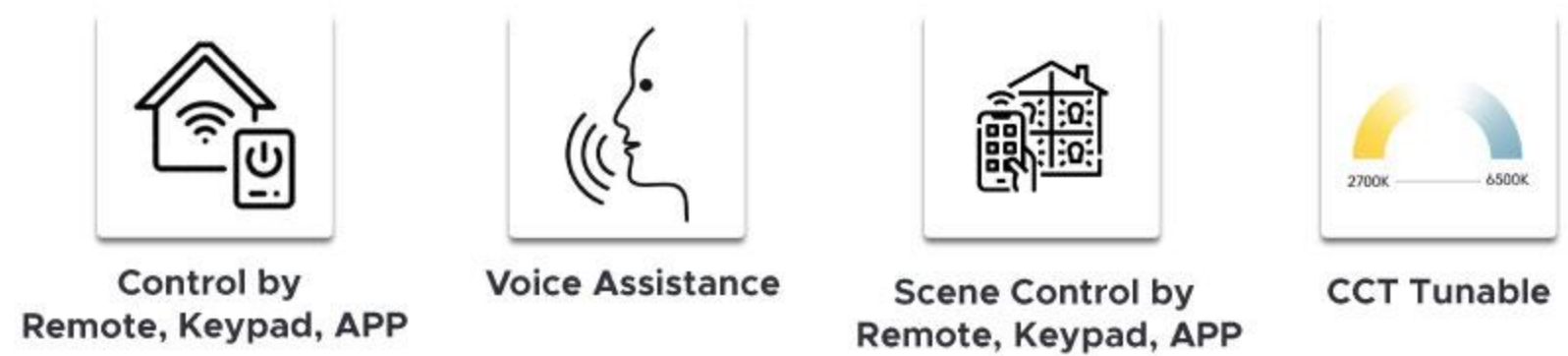

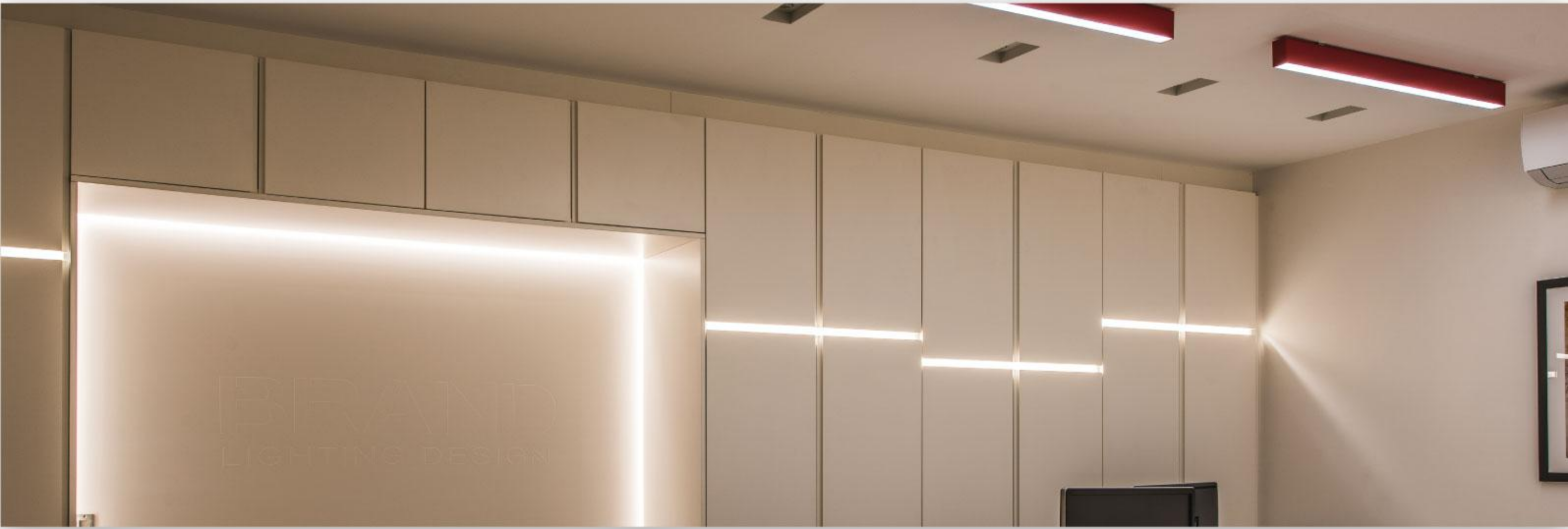

PRODUCT SPECIFICATIONS

Product Type : LED Flexible Strip Light

Product Name : LED Strip 15w/mtr. IP68

Product Code : UHLS-5050-60-IP68-15W

Wattage : 15W

CCT : 3000K / 4000K / 6000K

Voltage : 12V / 24V

External SMPS Driver Required

Special Color : Yes. On Request

IP Rating: IP68

Installation : 3M Adhesive

Lumens : 20-22LM

PCB : 8mm

Nos. of LED / Mtr : 60

DRIVER OPTIONS



SPECIAL ADDITIONAL FEATURES

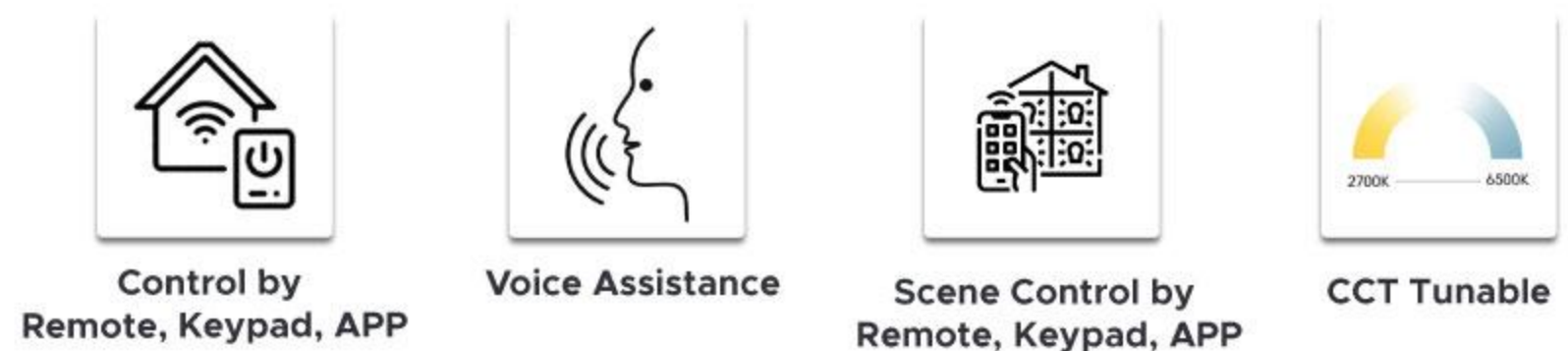



PRODUCT SPECIFICATIONS

Product Type : LED Flexiable Strip Light

Product Name : Led Strip 20W/ mtr 5mm

Product Code : UHLS-2835-168-20W-5MM

Wattage : 20W

CCT : 3000K / 4000K / 6000K

Voltage : 12V

External SMPS Driver Required

Special Color : Yes. On Request

IP Rating: IP20

Installation : 3m Adhesive

Lumens : 24-26LM

PCB : 5mm

Nos. of LED / Mtr : 168

DRIVER OPTIONS



SPECIAL ADDITIONAL FEATURES

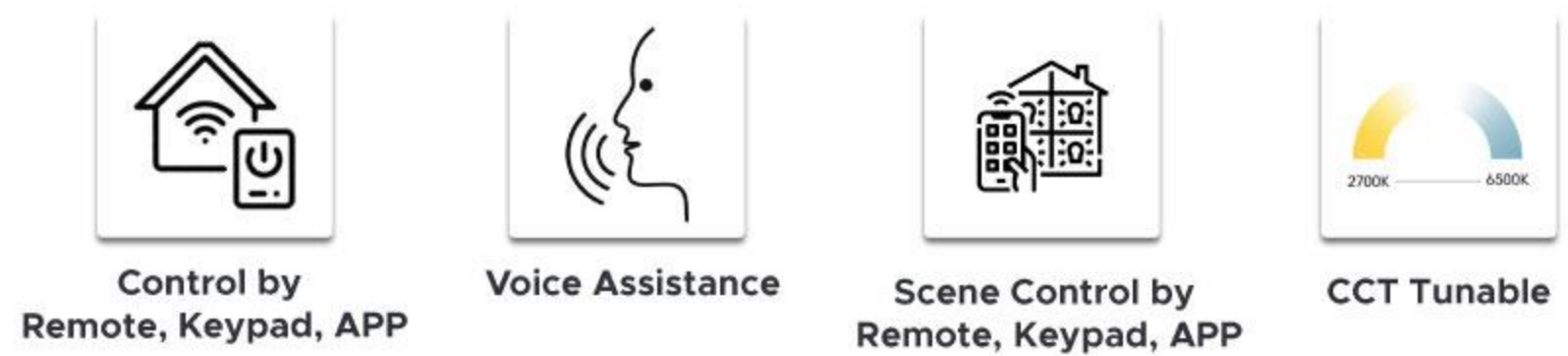



PRODUCT SPECIFICATIONS

Product Type : LED Flexible Strip Light

Product Name : Led Strip 20w/mtr

Product Code : UHLS-2835-168-20W

Wattage : 20W

CCT : 3000K

Voltage : 12V / 24V

External SMPS Driver Required

Special Color : Yes. On Request

IP Rating: IP20 / IP65

Installation : 3M Adhesive

Lumens : 8-10LM

PCB : 10mm

Nos. of LED / Mtr : 168

DRIVER OPTIONS



SPECIAL ADDITIONAL FEATURES

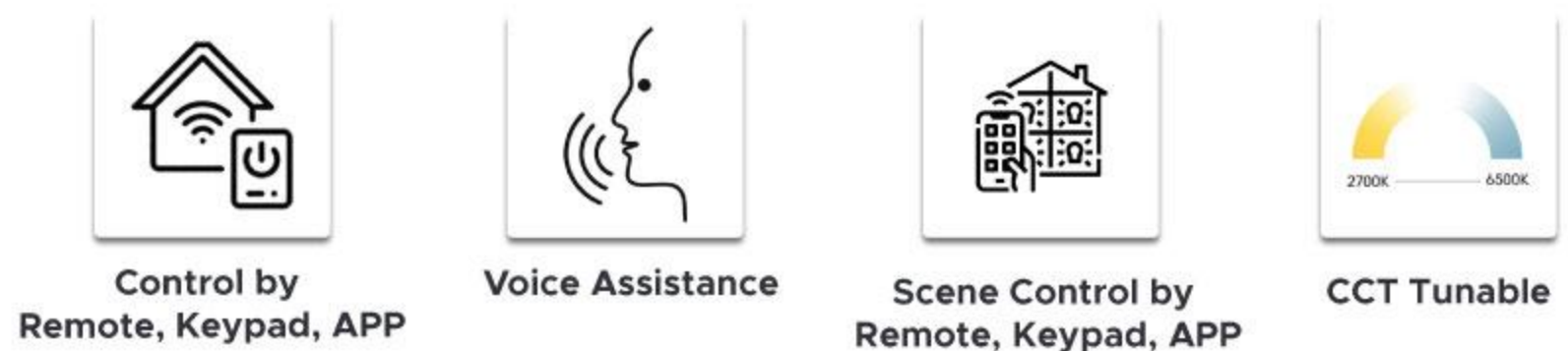



PRODUCT SPECIFICATIONS

Product Type : LED Flexible Strip Light

Special Color : Yes. On Request

Product Name : LED Strip 20w/mtr with German PCB

IP Rating: IP20

Product Code : UHLS-2835-168-20W-G

Installation : 3M Adhesive

Wattage : 20W/M

Lumens : 24-26LM

CCT : 3000K / 4000K / 6000K

PCB : 10mm

Voltage : 12V

Nos. of LED / Mtr : 168

External SMPS Driver Required

DRIVER OPTIONS



SPECIAL ADDITIONAL FEATURES

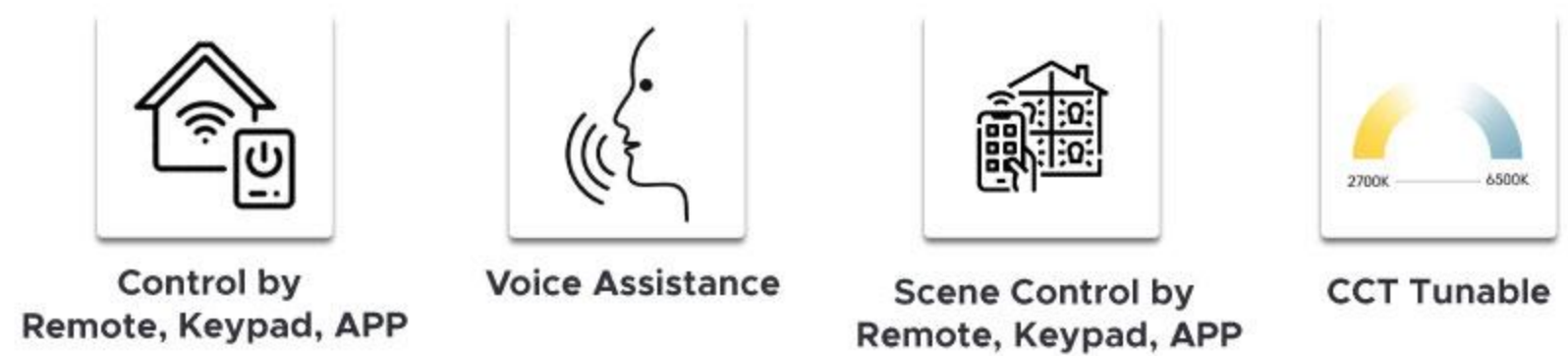



PRODUCT SPECIFICATIONS

Product Type : LED Flexible Strip Light

Product Name : Led Strip 16w/mtr Fireproof

Product Code : UHLS-2835-120

Wattage : 16W

CCT : 3000K / 4000K / 6000K

Voltage : 24V

External SMPS Driver Required

Special Color : Yes. On Request

IP Rating: IP20

Installation : 3M Adhesive

Lumens : 24-26LM

PCB : 5mm

Nos. of LED / Mtr : 168

DRIVER OPTIONS



SPECIAL ADDITIONAL FEATURES

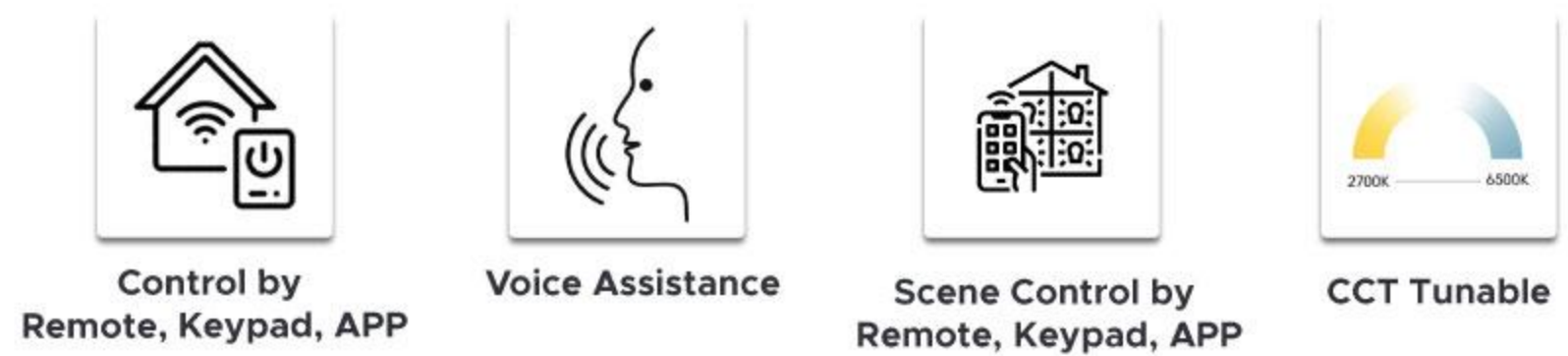



PRODUCT SPECIFICATIONS

Product Type : LED Flexible Strip Light

Product Name : LED Strip 22w/mtr

Product Code : UHLS-2835-192-22W

Wattage : 22W

CCT : 3000K / 4000K / 6000K

Voltage : 12V

External SMPS Driver Required

Special Color : Yes. On Request

IP Rating: IP20 / 65

Installation : 3M Adhesive

Lumens : 24-26LM

PCB : 10mm

Nos. of LED / Mtr : 192

DRIVER OPTIONS



SPECIAL ADDITIONAL FEATURES

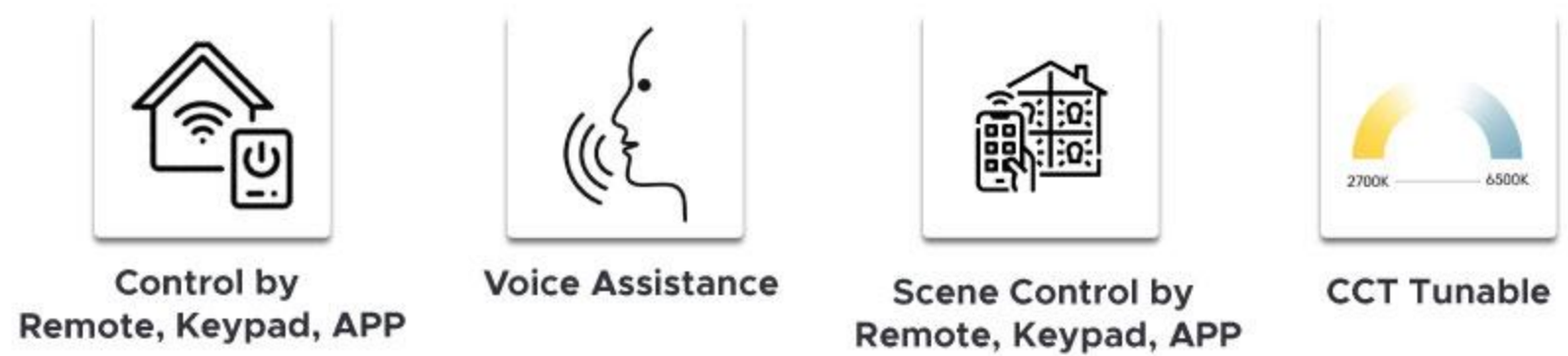



PRODUCT SPECIFICATIONS

Product Type : LED Flexible Strip Light

Product Name : LED Strip 24w/mtr

Product Code : UHLS-2835-2409-24W

Wattage : 24W

CCT : 3000K / 4000K / 6000K

Voltage : 12V

External SMPS Driver Required

Special Color : Yes. On Request

IP Rating: IP20 / 65

Installation : 3M Adhesive

Lumens : 24-26LM

PCB : 10mm

Nos. of LED / Mtr : 240

DRIVER OPTIONS



SPECIAL ADDITIONAL FEATURES

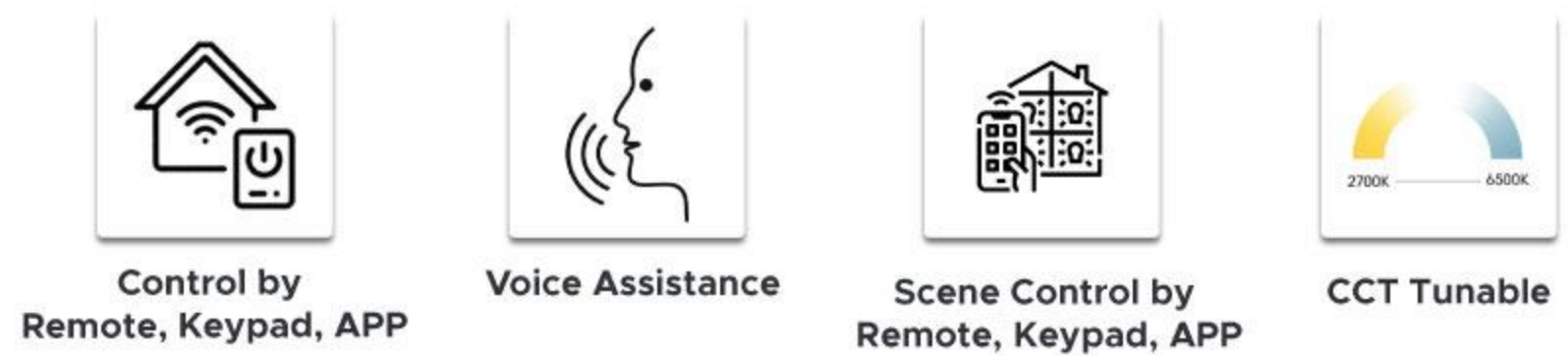



PRODUCT SPECIFICATIONS

Product Type : LED Flexible Strip Light

Special Color : Yes. On Request

Product Name : LED Strip 24w/mtr Double-line

IP Rating: IP20

Product Code : UHLS-2835-240-24W

Installation : 3M Adhesive

Wattage : 24W

Lumens : 24-26LM

CCT : 3000K / 4000K / 6000K

PCB : 20mm

Voltage : 12V

Nos. of LED / Mtr : 192

External SMPS Driver Required

DRIVER OPTIONS



SPECIAL ADDITIONAL FEATURES

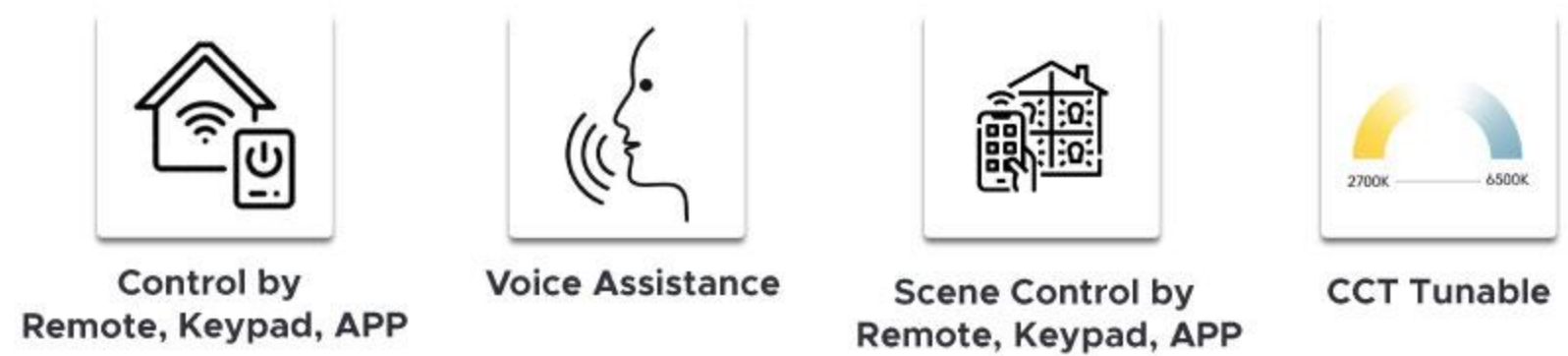



PRODUCT SPECIFICATIONS

Product Type : LED Flexible Strip Light

Product Name : LED Strip 36w/mtr 20mm

Product Code : UHLS-2110-700-36W

Wattage : 36W

CCT : 3000K / 4000K

Voltage : 24V

External SMPS Driver Required

Special Color : Yes. On Request

IP Rating: 20 IP

Installation : 3M Adhesive

Lumens : 24-26LM

PCB : 20mm

Nos. of LED / Mtr : 700

DRIVER OPTIONS



SPECIAL ADDITIONAL FEATURES

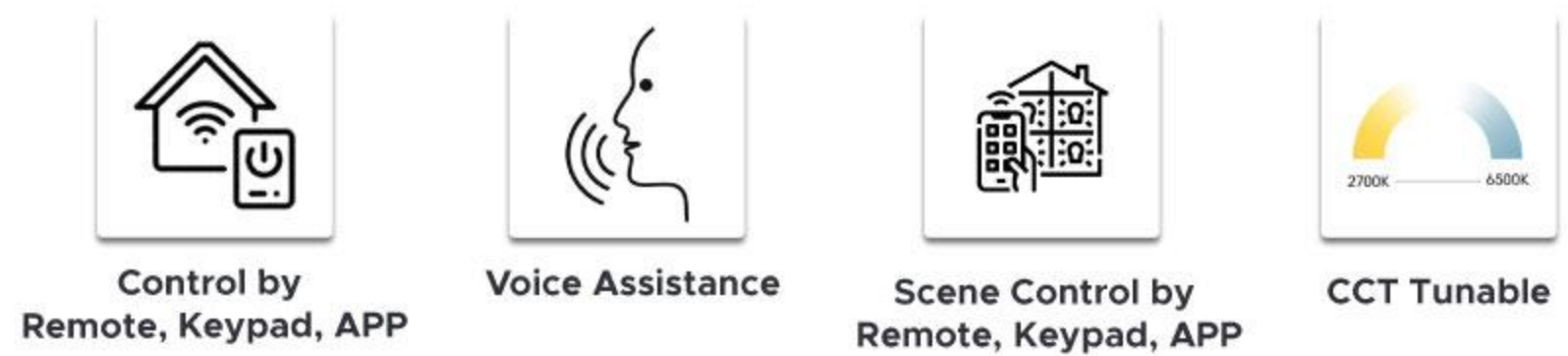



PRODUCT SPECIFICATIONS

Product Type : LED Flexible Strip Light

Special Color : Yes. On Request

Product Name : LED Strip 48w/mtr Triple Line

IP Rating: IP20

Product Code : UHLS-2835-360-48W

Installation : 3M Adhesive

Wattage : 48W

Lumens : 18-20LM

CCT : 3000K / 4000K / 6000K

PCB : 30mm

Voltage : 12V

Nos. of LED / Mtr : 360

External SMPS Driver Required

DRIVER OPTIONS



SPECIAL ADDITIONAL FEATURES

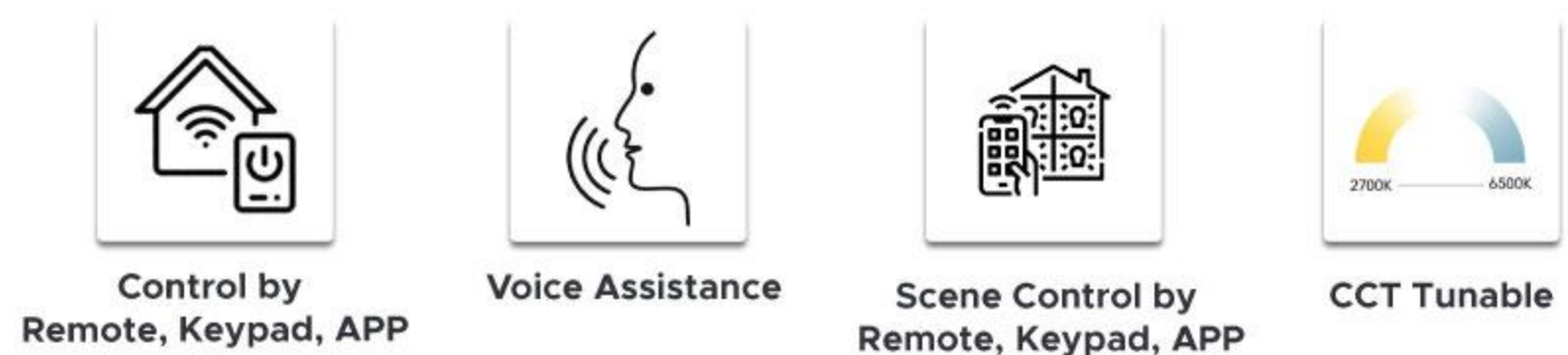

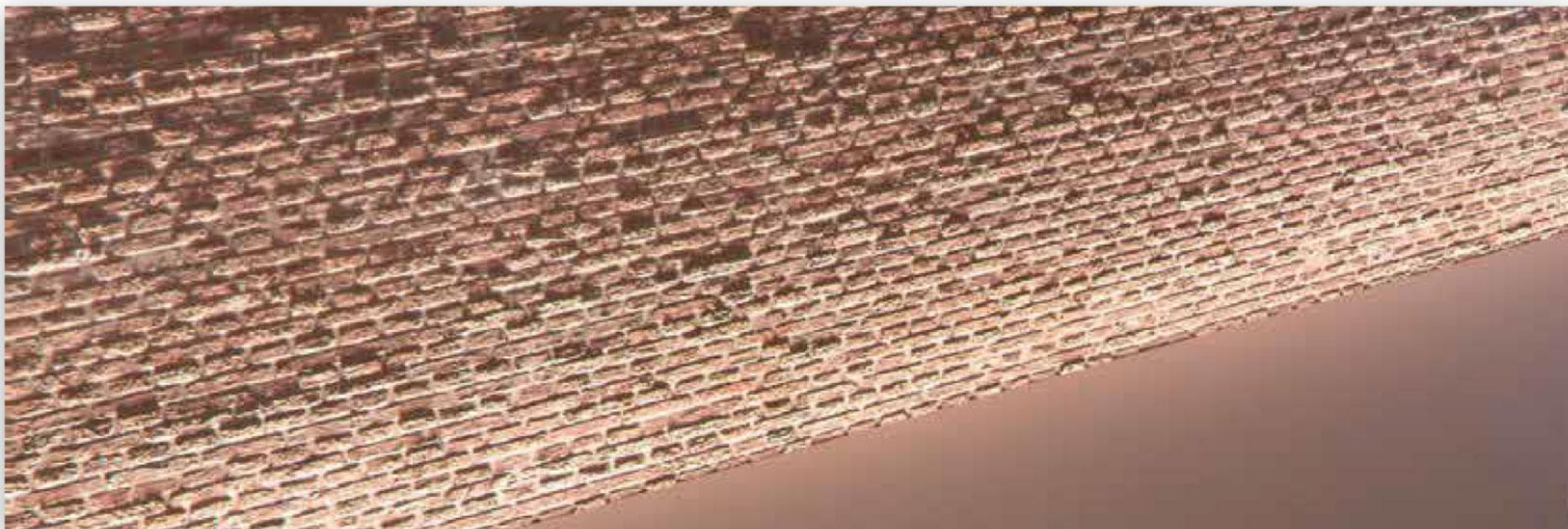

PRODUCT SPECIFICATIONS

Product Type : LED FlexibleStrip Light

Product Name : Neon Lens Wall Grazer

Product Code : UHLS-FLEXIBLE-LENS-WALL-WASHER

Wattage : 21W/M

CCT : 2700K / 3000K

Special Color: Yes. On Request

IP Rating: IP65

Cutting Mark : Per 6 Leds

Dimension: 20mm x 19mm

Voltage: 24V

External SMPS Driver Required

DRIVER OPTIONS



SPECIAL ADDITIONAL FEATURES

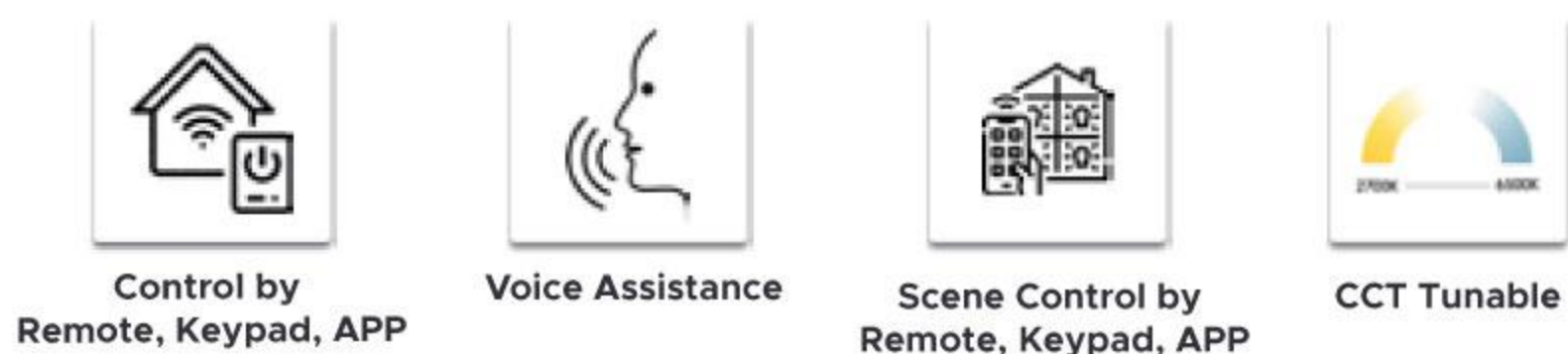

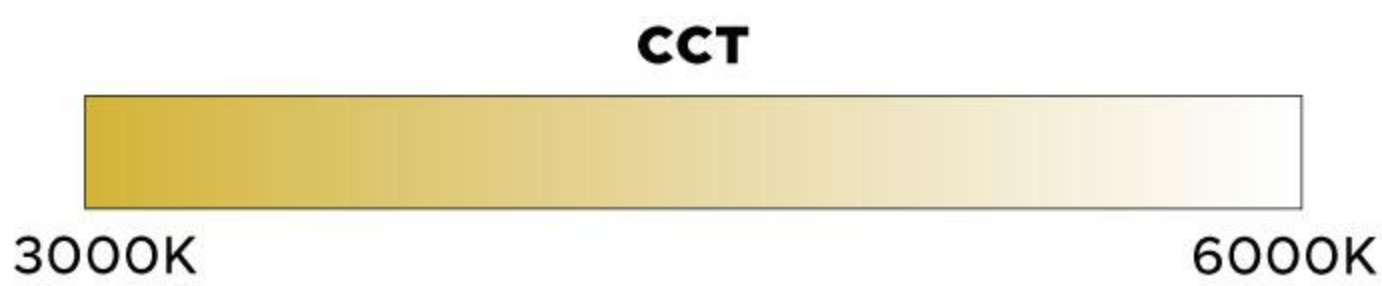

PRODUCT SPECIFICATIONS

Product Type : LED Flexible Strip Light

Special Color : CCT Tunable

Product Name : LED Strip 20w/mtr CCT Tunable

IP Rating: IP20

Product Code : UHLS-2835-168-CCT-20W

Installation : 3M Adhesive

Wattage : 20W

Lumens : 24-26LM

CCT : 3000K to 6000K

PCB : 10mm

Voltage : 12V

Nos. of LED / Mtr : 168 (CCT Tunable)

External SMPS Driver Required

DRIVER OPTIONS



SPECIAL ADDITIONAL FEATURES

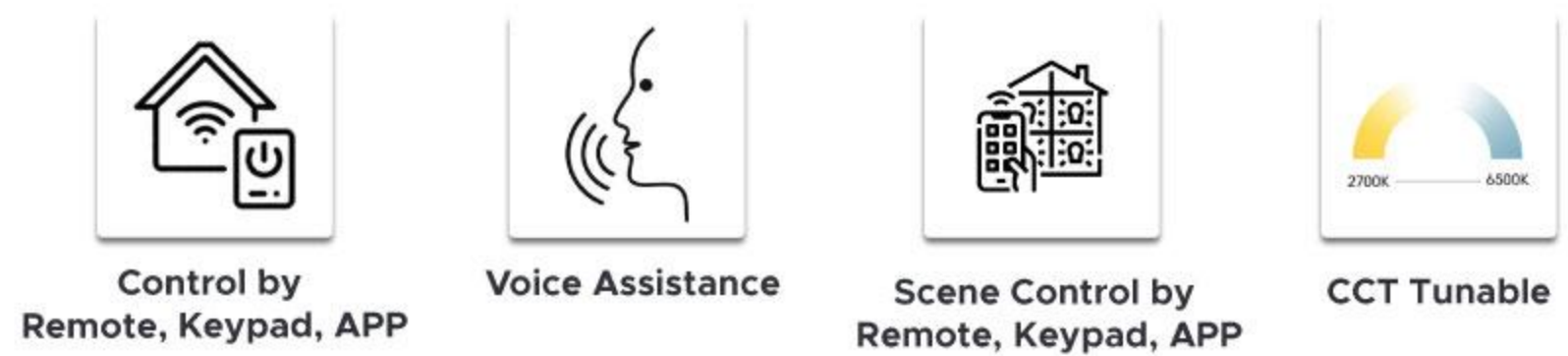



CCT



PRODUCT SPECIFICATIONS

Product Type : LED Flexible Strip Light

Special Color : CCT Tunable

Product Name : LED Strip 22w/mtr CCT Tunable

IP Rating: IP20

Product Code : UHLS-2835-192-CCT-22W

Installation : 3M Adhesive

Wattage : 22W

Lumens : 24-26LM

CCT : 3000K to 6000K

PCB : 10mm

Voltage : 12V / 24V

Nos. of LED / Mtr : 192 (CCT Tunable)

External SMPS Driver Required

DRIVER OPTIONS



SPECIAL ADDITIONAL FEATURES

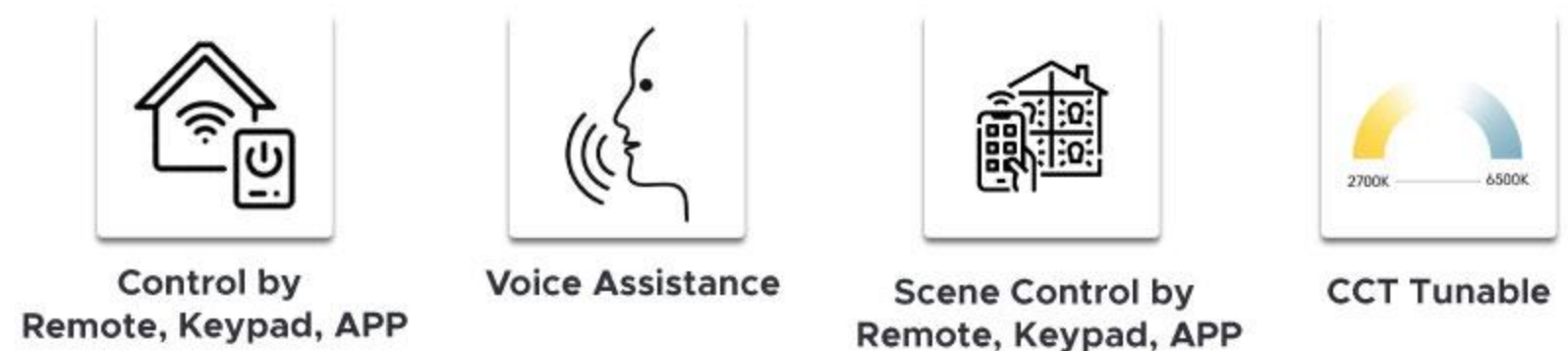



RGB



CCT



3000K



PRODUCT SPECIFICATIONS

Product Type : LED Flexible Strip Light

Special Color : RGB + WW

Product Name : LED Strip 18w/mtr

IP Rating: IP20

Product Code : UHLS-5050-60-RGBWW-18W

Installation : 3M Adhesive

Wattage : 18W

Lumens : 24-26LM

CCT : RGB+3000K

PCB : 10mm

Voltage : 12V

Nos. of LED / Mtr : 60

External SMPS Driver Required

DRIVER OPTIONS



SPECIAL ADDITIONAL FEATURES

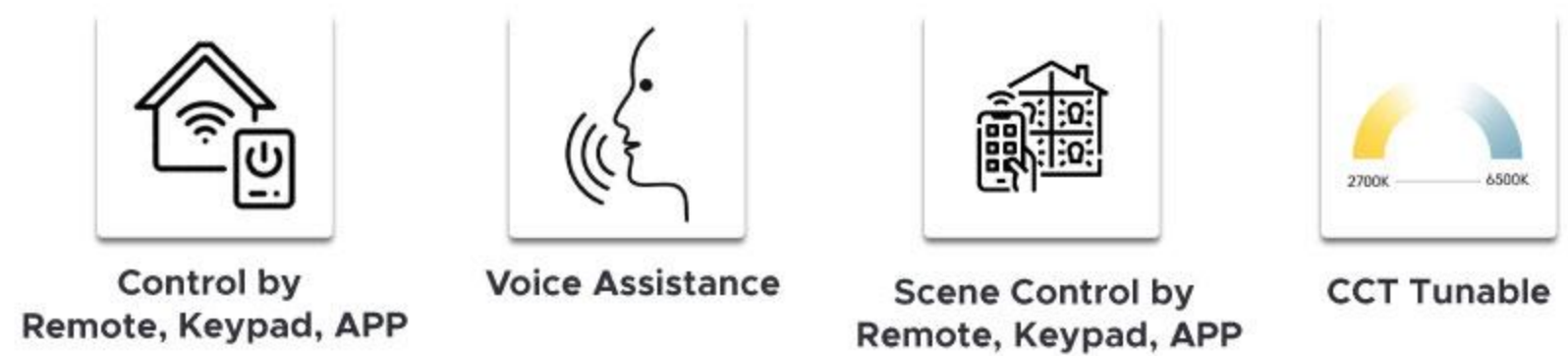

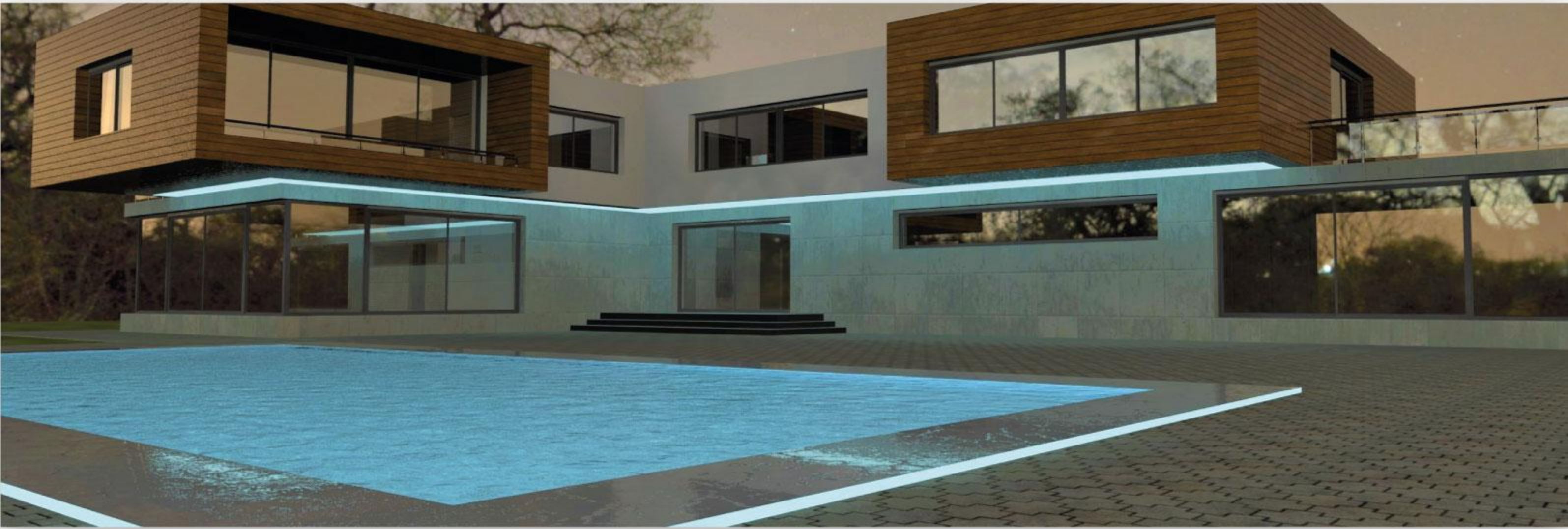

RGB



CCT



3000K

6000K



PRODUCT SPECIFICATIONS

Product Type : LED Flexible Strip Light

Special Color: RGB + CCT Tunable

Product Name : LED Strip 15w/mtr RGB + CCT Tunable

IP Rating: IP20 / 65

Product Code : UHLS-5050-60-RGB-CCT-15W

Installation : 3M Adhesive

Wattage : 15W

Lumens : 18-20LM

CCT : 3000K to 6000K / RGB

PCB : 10mm

Voltage : 12V

Nos. of LED / Mtr : 60

External SMPS Driver Required

DRIVER OPTIONS



SPECIAL ADDITIONAL FEATURES

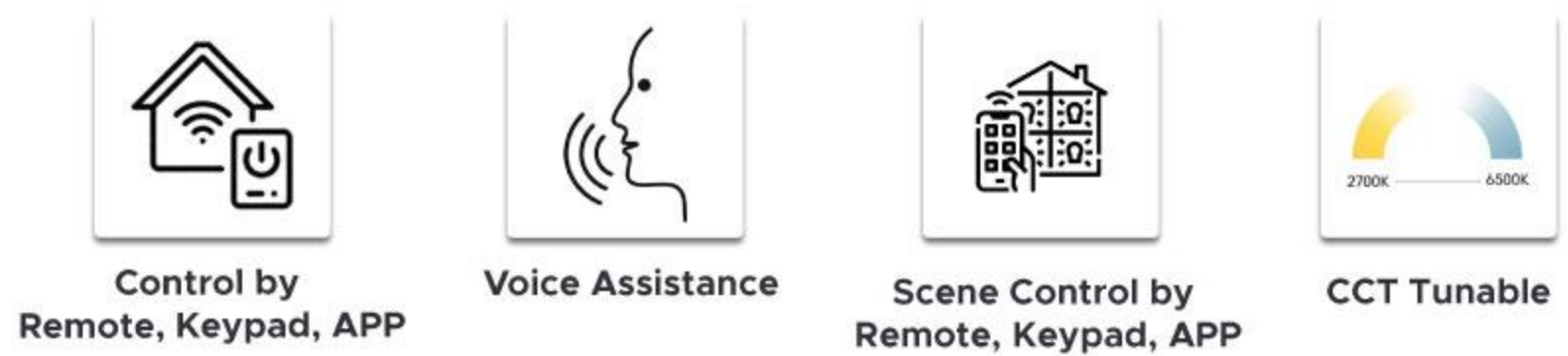



RGB



PRODUCT SPECIFICATIONS

Product Type : LED Flexible Strip Light

Product Name : LED Strip 8-14w/mtr RGB

Product Code : UHLS-5050-60-RGB-8W-14W

Wattage : 8W / 14W

CCT : RGB

Voltage : 12v

External SMPS Driver Required

Special Color: RGB Controllable

IP Rating: IP20/65

Installation : 3M Adhesive

Lumens : 8-10 LM / 24-26 LM

PCB : 10mm

Nos. of LED / Mtr : 30 / 60

DRIVER OPTIONS



SPECIAL ADDITIONAL FEATURES

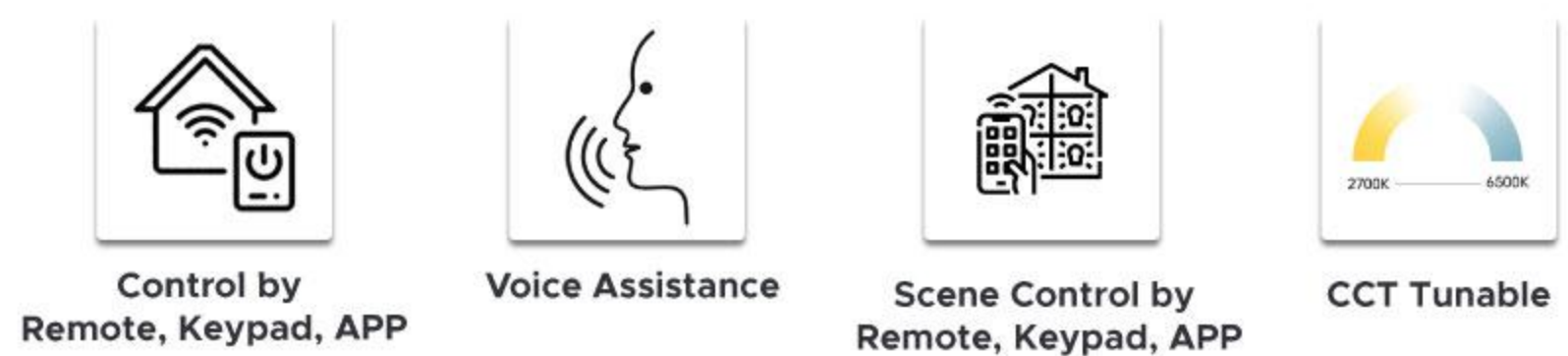



RGB



PRODUCT SPECIFICATIONS

Product Type : LED Flexible Strip Light

Product Name : LED Strip 20w/mtr RGB

Product Code : UHLS-3535-144-RGB-20W

Wattage : 20W

CCT : RGB

Voltage : 12V

External SMPS Driver Required

Special Color: RGB Controllable

IP Rating: IP20/65

Installation : 3M Adhesive

Lumens : 24-26LM

PCB : 10mm

Nos. of LED / Mtr : 144

DRIVER OPTIONS



SPECIAL ADDITIONAL FEATURES

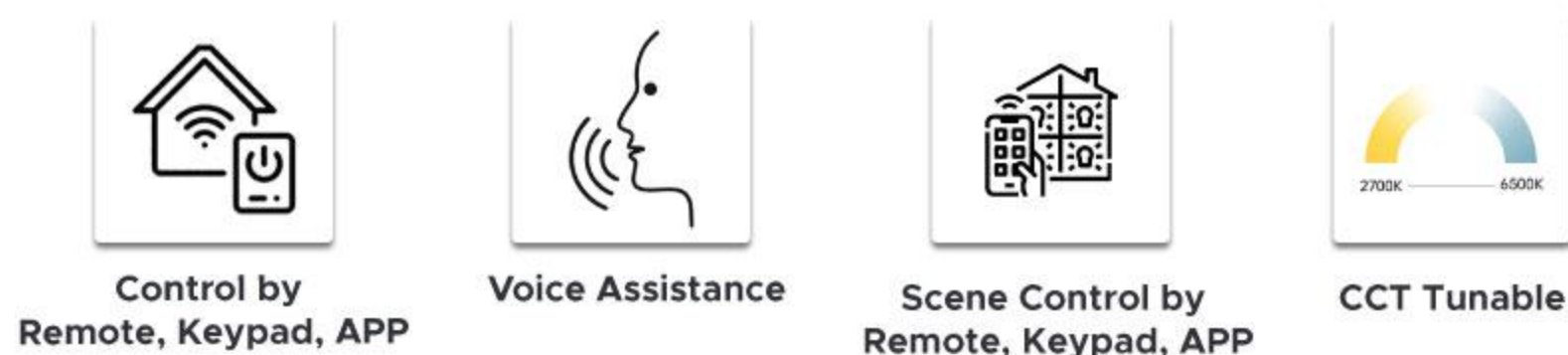



RGB



CCT



3000K

6000K



PRODUCT SPECIFICATIONS

Product Type : LED Flexible Strip Light

Product Name : LED Strip 18w/mtr RGB

Product Code : UHLS-5050-60-RGBWW

Wattage : 18W

CCT : RGB + 3000K

Voltage : 12V / 24V

External SMPS Driver Required

Special Color : RGB + WW

IP Rating: IP20

Installation: 3M Adhesive

Lumens: 18-20 LM

PCB : 10mm

Nos. of LED / Mtr : 60

DRIVER OPTIONS

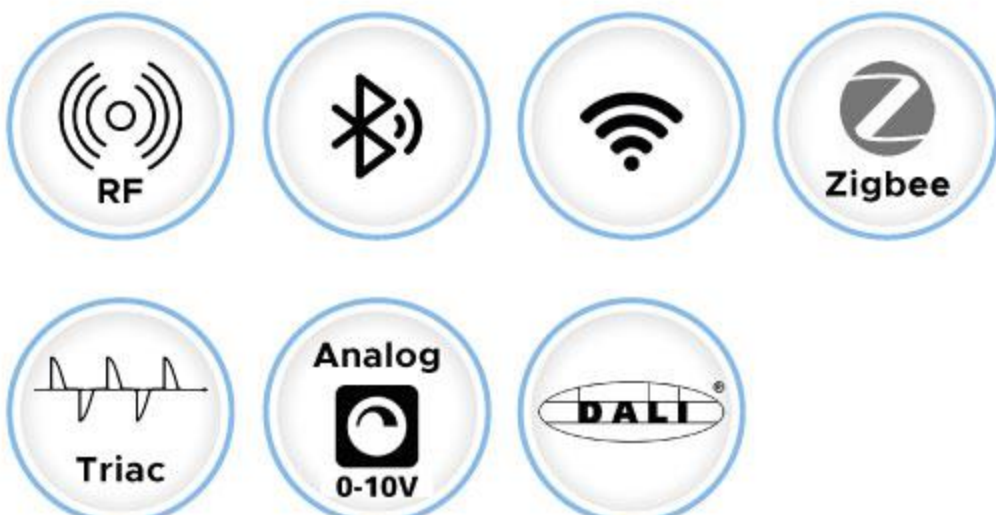

SPECIAL ADDITIONAL FEATURES

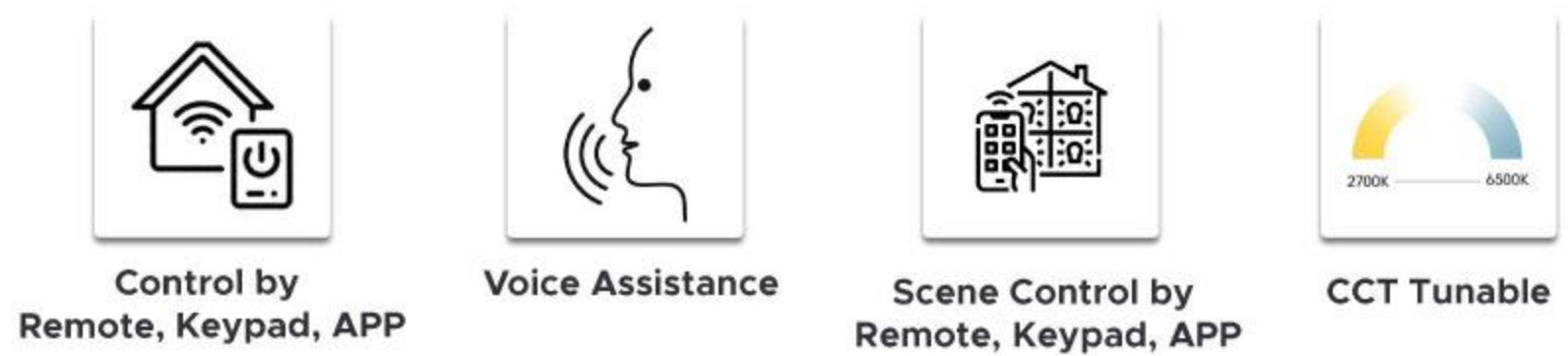



PRODUCT SPECIFICATIONS

Product Type : LED Flexible Strip Light

Product Name : Neon Flex 24V

Product Code : UHLS-24V-NEON-FLEX-12W

Wattage : 12W/M

CCT : 3000K / 4000K / 6000K

Special Color: Yes. On Request

IP Rating: IP20

Cutting Mark : Per 6 Leds

Dimension: 13mm x 6mm

Voltage: 24V

External SMPS Driver Required

DRIVER OPTIONS



SPECIAL ADDITIONAL FEATURES



Control by Remote, Keypad, APP



Voice Assistance



Scene Control by Remote, Keypad, APP

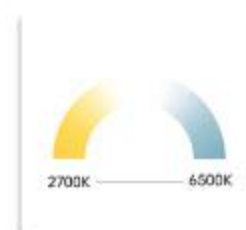

CCT Tunable

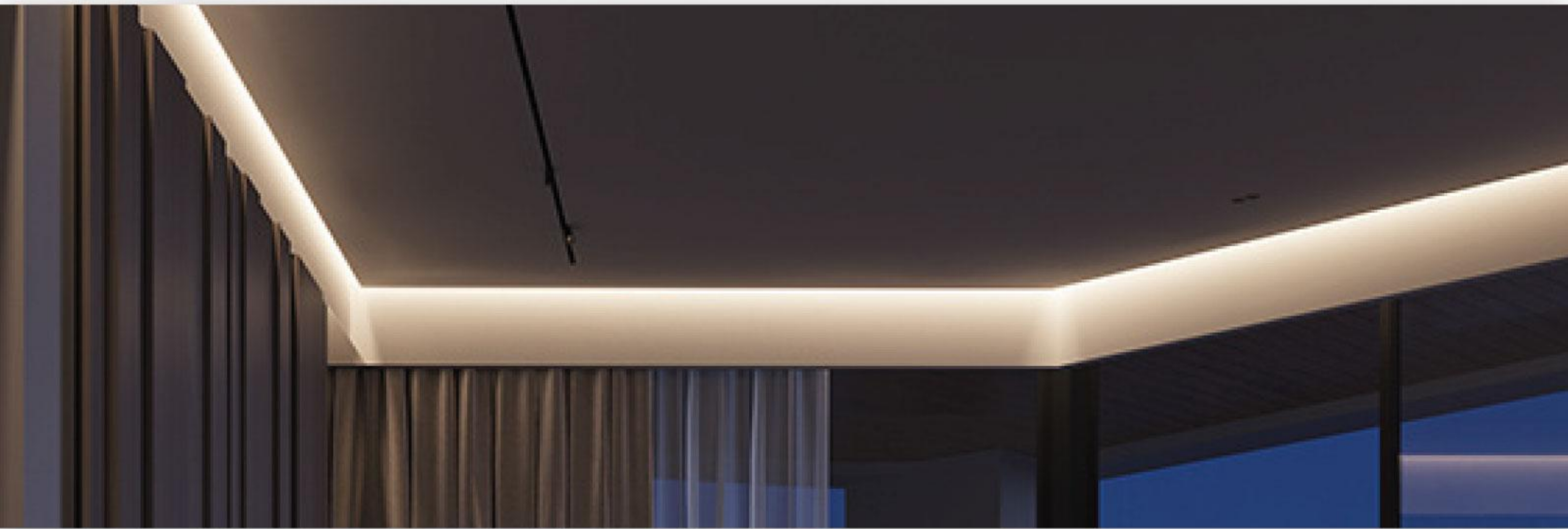

PRODUCT SPECIFICATIONS

Product Type : LED Fexible Strip Light

Product Name : Rope Light

Product Code : UHLS-2836-60-SMD-ROPE-6W

Wattage : 06W

CCT : 3000K / 4000K / 6000K

Voltage : 220v

Special Color: Yes. On Request

IP Rating: IP20 / IP65

Cutting Mark : Per 1 mtr

Lumens : 24-26LM

Length : 50 mtr / Roll

DRIVER OPTIONS



SPECIAL ADDITIONAL FEATURES

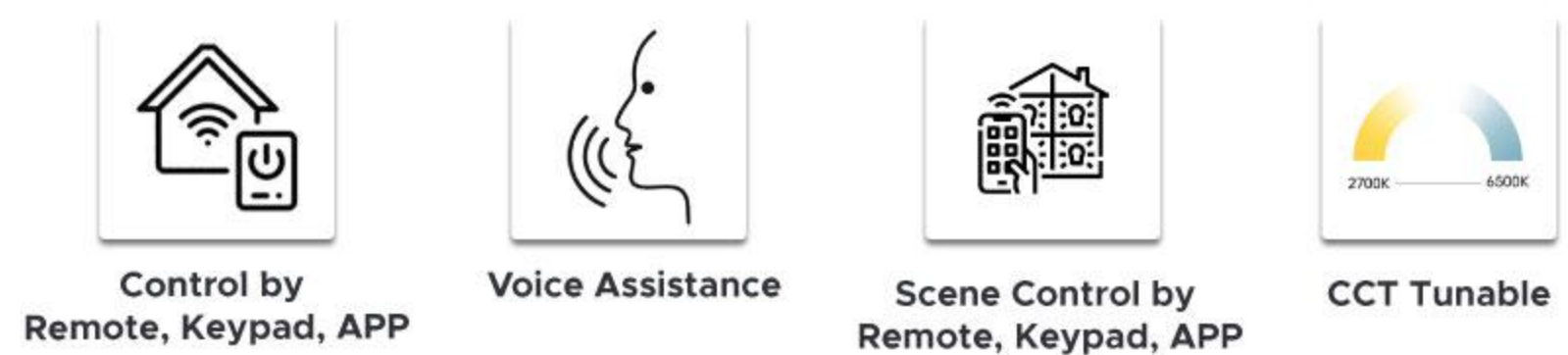

Control by Remote, Keypad, APP

Voice Assistance

Scene Control by Remote, Keypad, APP

CCT Tunable



PRODUCT SPECIFICATIONS

Product Type : LED Flexible Strip Light

Product Name : COB Strip 11w/ mtr 8mm

Product Code : UHLS-COB-384-D

Wattage : 11W/M

CCT : 3000K / 4000K / 6000K

Voltage : 24V

Special Color : Yes. On Request

IP Rating: IP44

Installation : 3M Adhesive

PCB : 8mm

Nos. of LED / Mtr : 384

External SMPS Driver Required

DRIVER OPTIONS



SPECIAL ADDITIONAL FEATURES

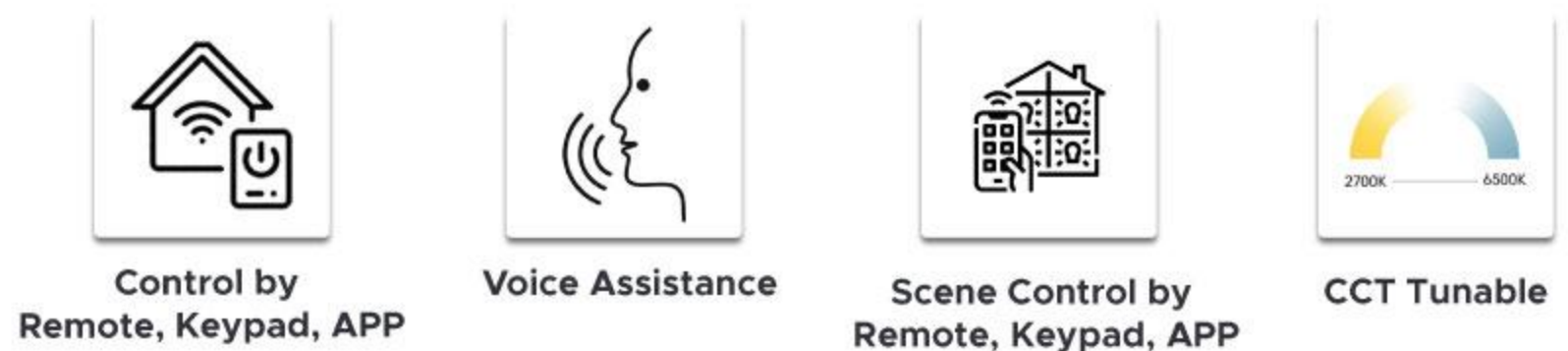



PRODUCT SPECIFICATIONS

Product Type : LED Flexible Strip Light

Product Name : COB Strip 11w/ mtr 5mm

Product Code : UHLS-COB 400D-5MM

Wattage : 11W/M

CCT : 3000K / 4000K / 6000K

Voltage : 24V

External SMPS Driver Required

Special Color : Yes. On Request

IP Rating: IP44

Installation : 3M Adhesive

Lumens : 24-26LM

PCB : 5mm

Nos. of LED / Mtr : 400

DRIVER OPTIONS



SPECIAL ADDITIONAL FEATURES

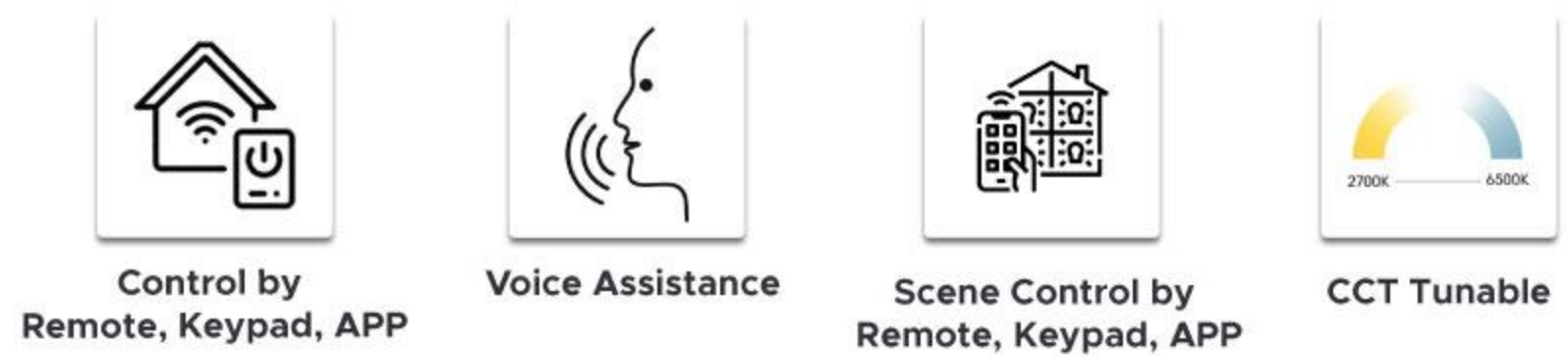



PRODUCT SPECIFICATIONS

Product Type : LED Flexible Strip Light

Product Name : COB Strip 21w/ mtr 10mm

Product Code : UHLS-COB-576D-CCT

Wattage : 21W/M

CCT : 2700K to 6500K

Voltage : 24V

External SMPS Driver Required

Special Color : Yes. On Request

IP Rating: IP44

Installation : 3M Adhesive

Lumens : 24-26LM

PCB : 10mm

Nos. of LED / Mtr : 576

DRIVER OPTIONS



SPECIAL ADDITIONAL FEATURES

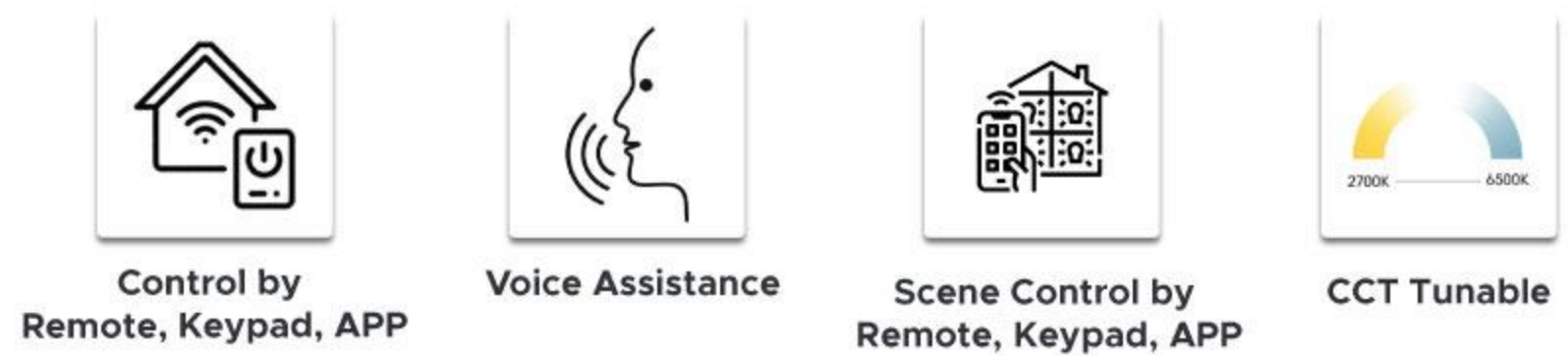

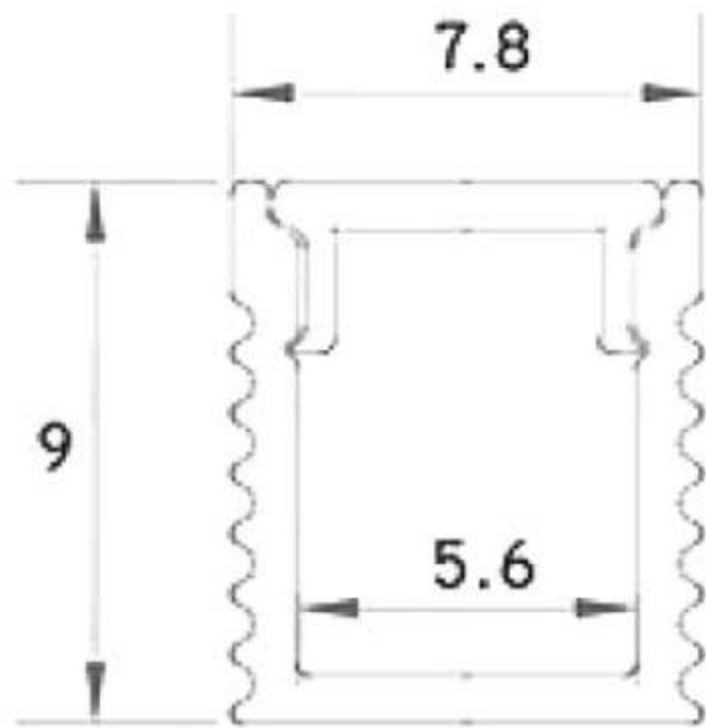

PRODUCT SPECIFICATIONS

Product Type : LED Strip Profile

Product Name : 8A Surface

Product Code : UHLS-8A-SURFACE

Color: Silver-Grey

Diffuser : PMMA

IP Rating: IP44

Mounting Type: Surface

Accessories : End Caps & Back Clamps

DRIVER OPTIONS



SPECIAL ADDITIONAL FEATURES

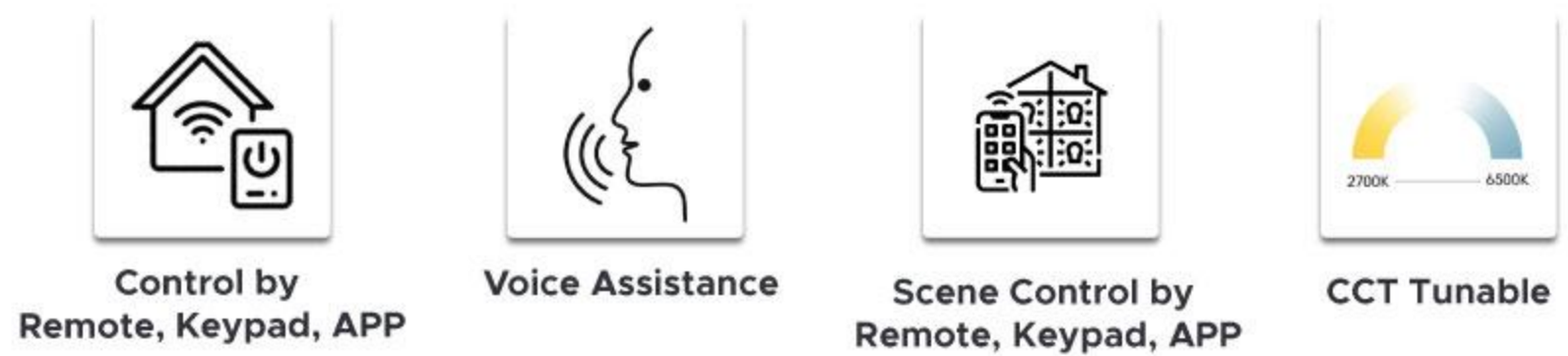

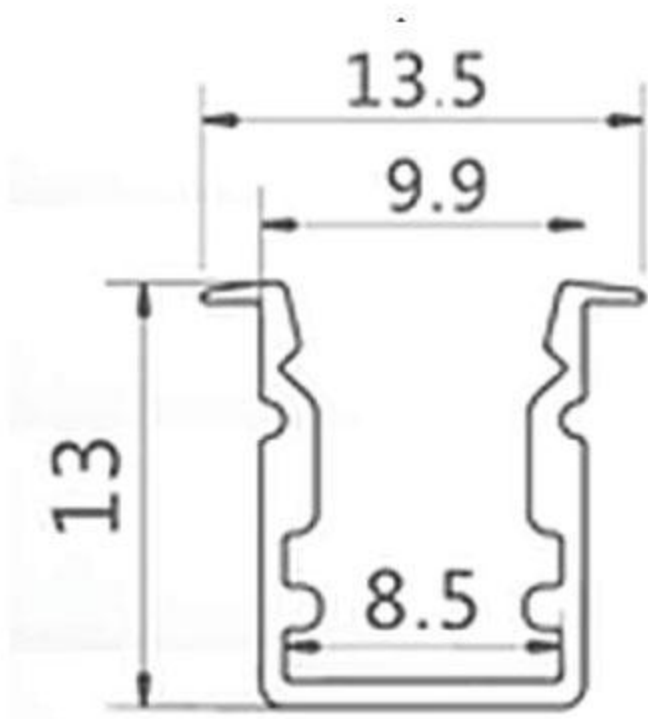
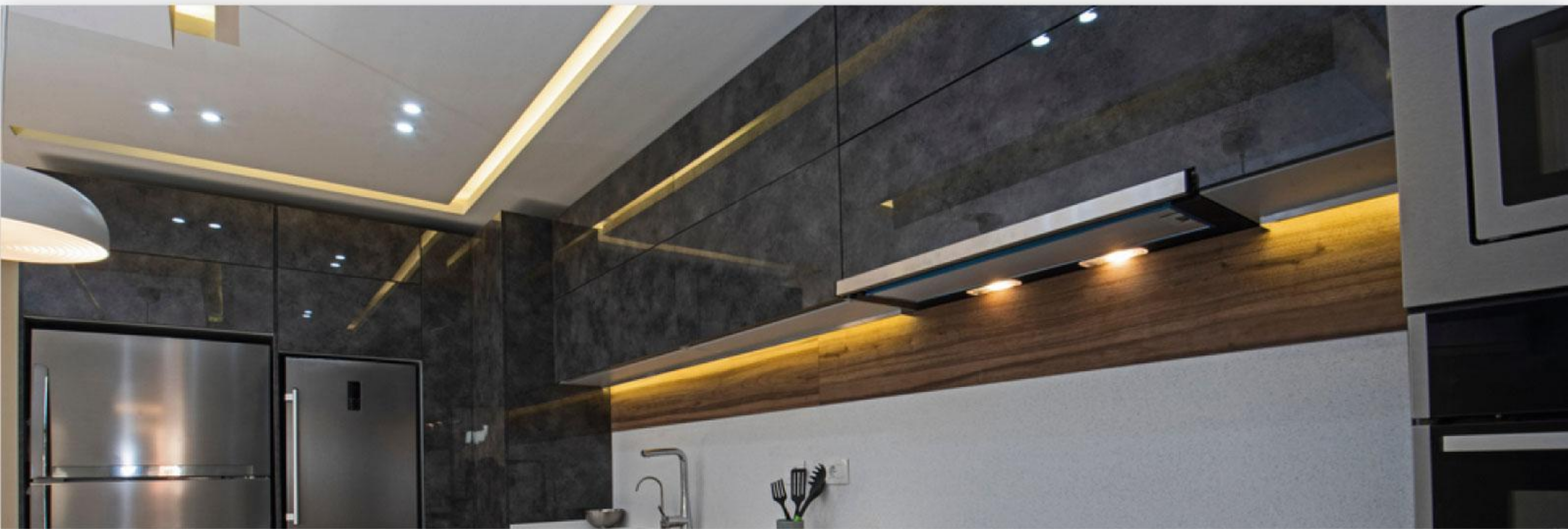

PRODUCT SPECIFICATIONS

Product Type : LED Strip Profile

Product Name : 8B Concealed

Product Code : UHLS-8B-CONCEALED

Color: Silver-Grey

Diffuser : PMMA

IP Rating: IP 44

Mounting : Concealed

Accessories: End Caps & Back Clamps

DRIVER OPTIONS



SPECIAL ADDITIONAL FEATURES

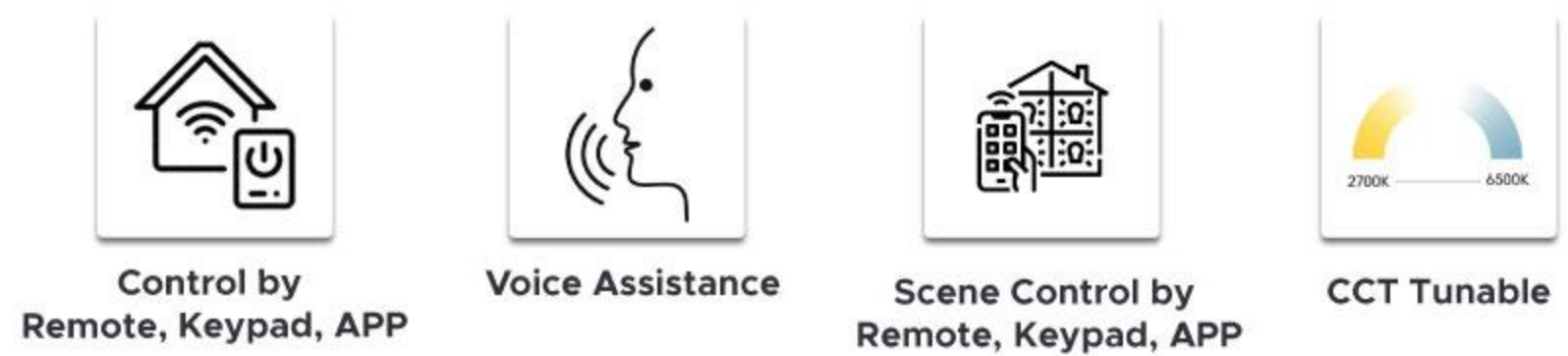

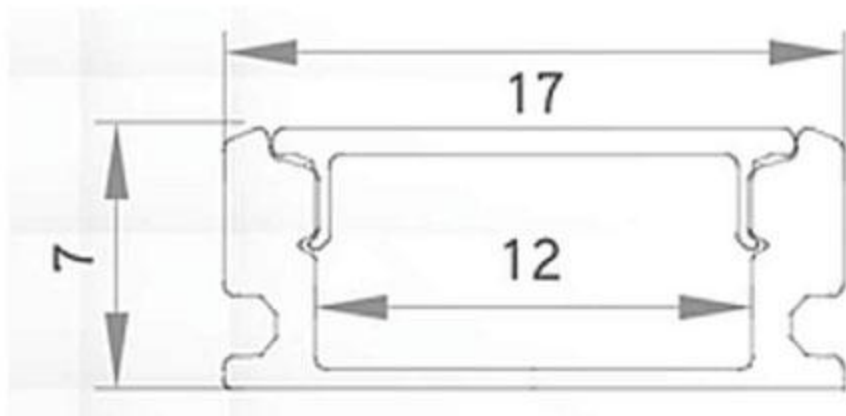

PRODUCT SPECIFICATIONS

Product Type : LED Strip Profile

Product Name : 17A Surface

Product Code : UHLS-17A-SURFACE

Color: Silver-Grey

Diffuser : PMMA

IP Rating: IP 44

Mounting Type : Surface

Accessories : End Caps & Back Clamps

DRIVER OPTIONS



SPECIAL ADDITIONAL FEATURES

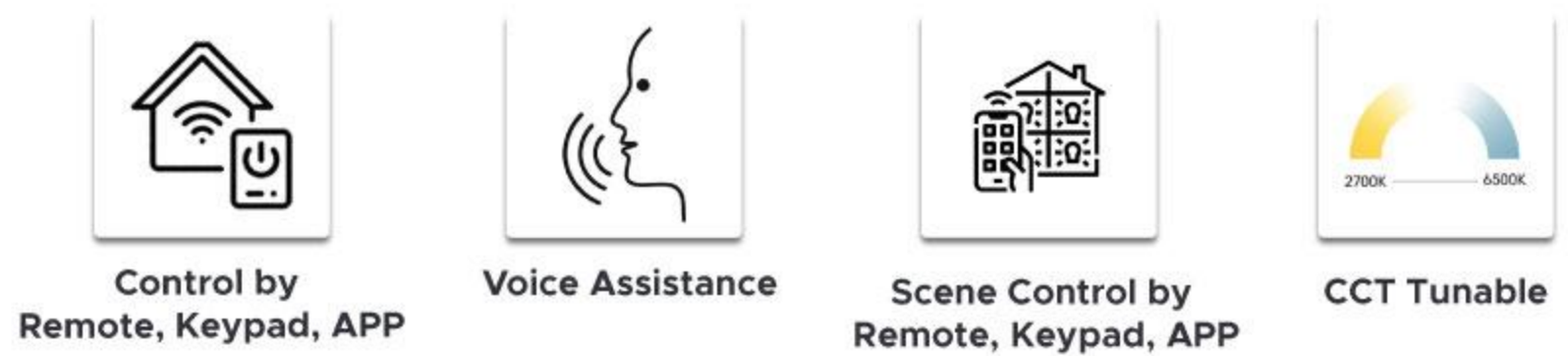

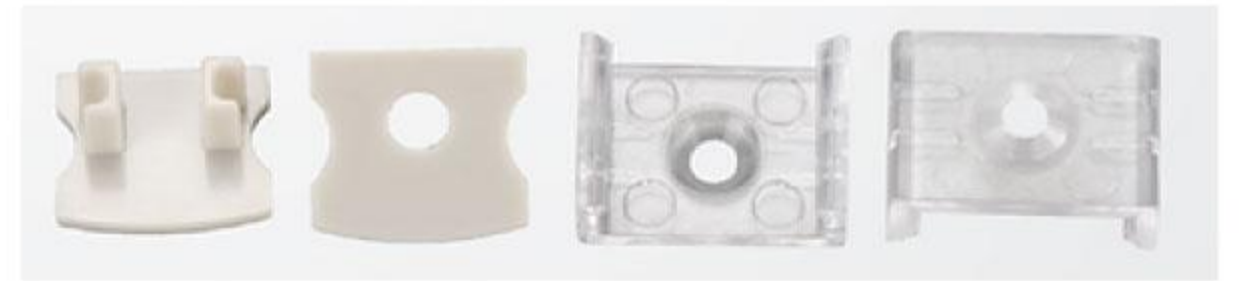
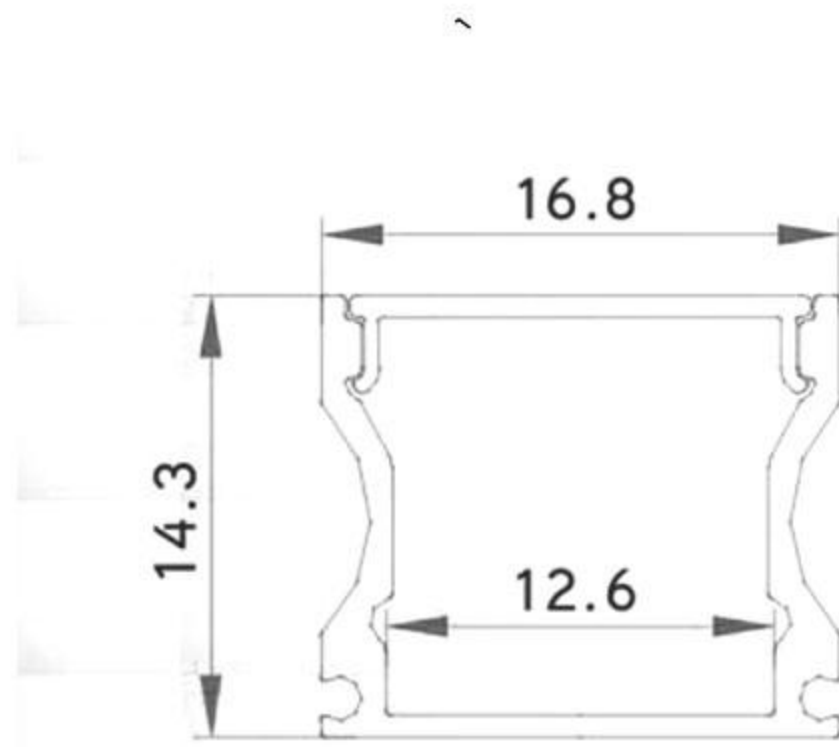

PRODUCT SPECIFICATIONS

Product Type : LED Strip Profile

Product Name : 17A Deep Surface

Product Code : UHLS-17A-DEEP-SURFACE

Color: Silver-Grey

Diffuser : PMMA

IP Rating: IP44

Mounting Type: Surface

Accessories : End Caps & Back Clamps

DRIVER OPTIONS



SPECIAL ADDITIONAL FEATURES

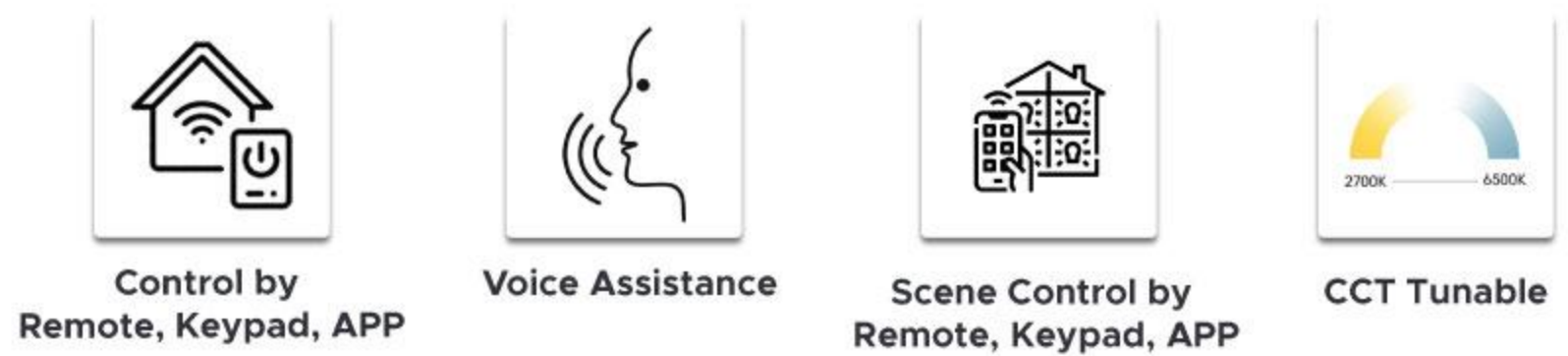

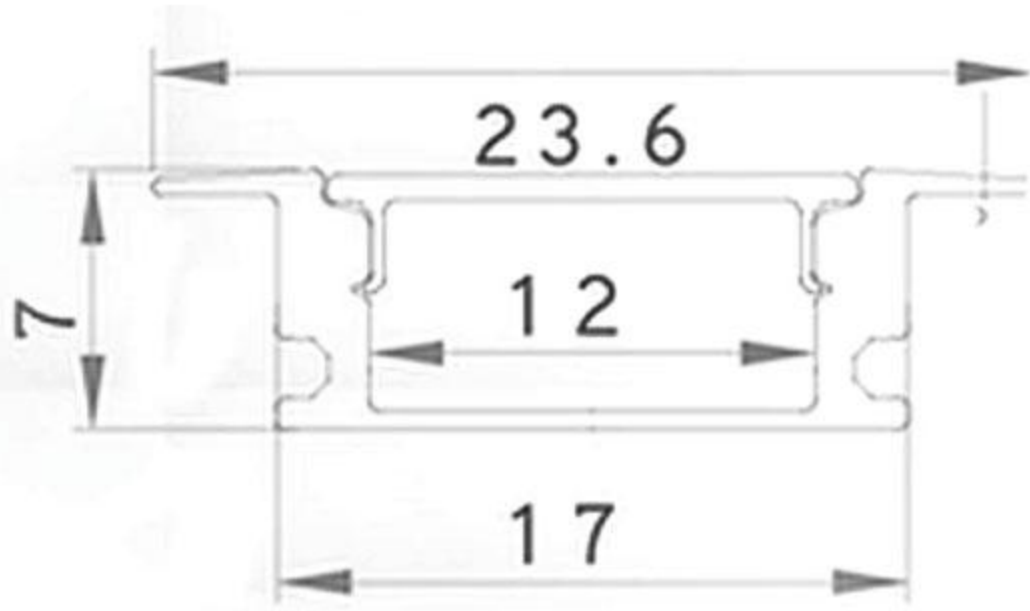

PRODUCT SPECIFICATIONS

Product Type : LED Strip Profile

Diffuser : PMMA

Product Name : 17B Concealed

IP Rating: IP 44

Product Code : UHLS-17B-CONCEALED

Mounting Type: Concealed

Color: Silver-Grey

Accessories : End Caps & Back Clamps

DRIVER OPTIONS



SPECIAL ADDITIONAL FEATURES

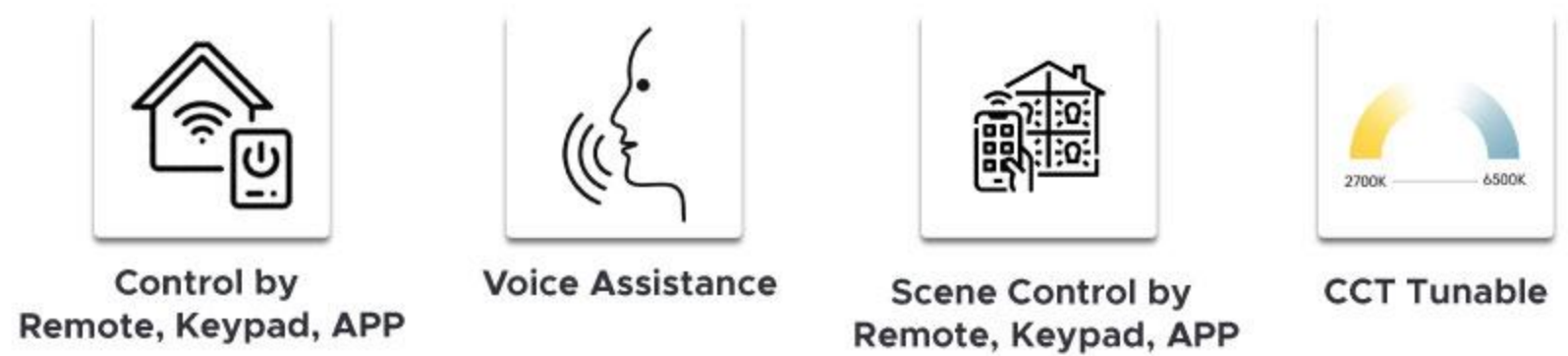

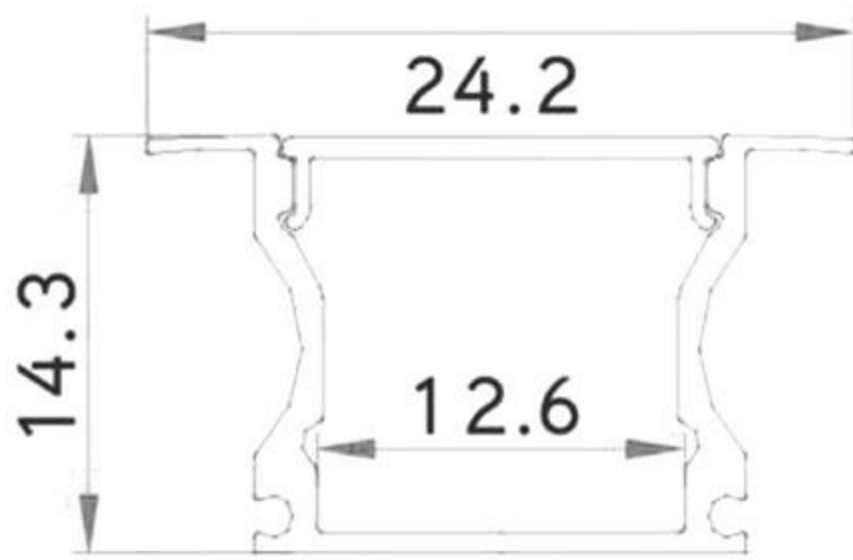

PRODUCT SPECIFICATIONS

Product Type : LED Strip Profile

Diffuser : PMMA

Product Name : 17B Deep Concealed

IP Rating: IP 44

Product Code : UHLS-17B-DEEP-CONCEALED

Mounting Type: Concealed

Color: Silver-Grey

Accessories : End Caps & Back Clamps

DRIVER OPTIONS



SPECIAL ADDITIONAL FEATURES

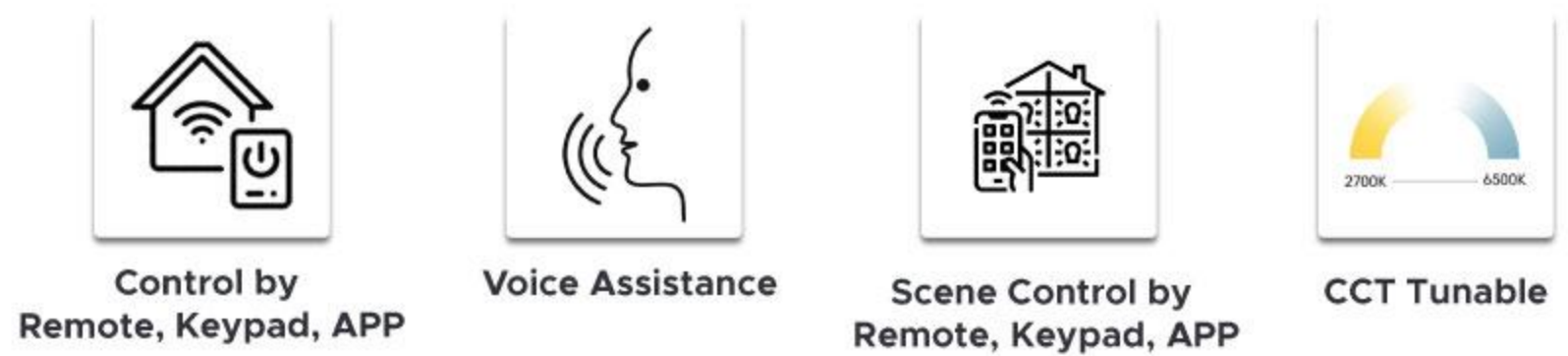

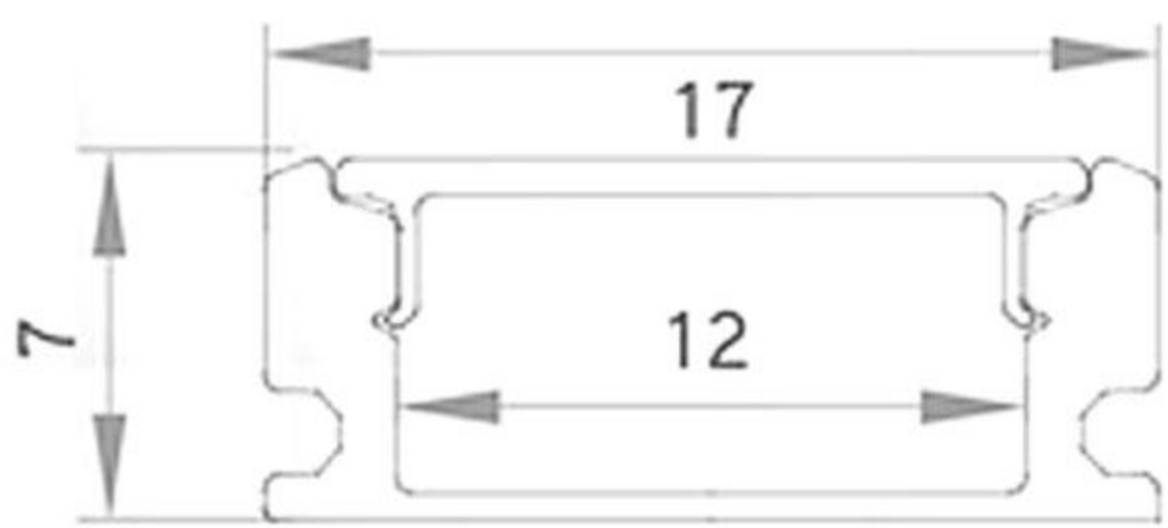

PRODUCT SPECIFICATIONS

Product Type : LED Strip Profile

Product Name : 17C Surface

Product Code : UHLS-17C-SURFACE

Color: Silver-Grey

Diffuser : PMMA

IP Rating: IP 44

Mounting Type: Surface

External SMPS Driver Required

DRIVER OPTIONS



SPECIAL ADDITIONAL FEATURES

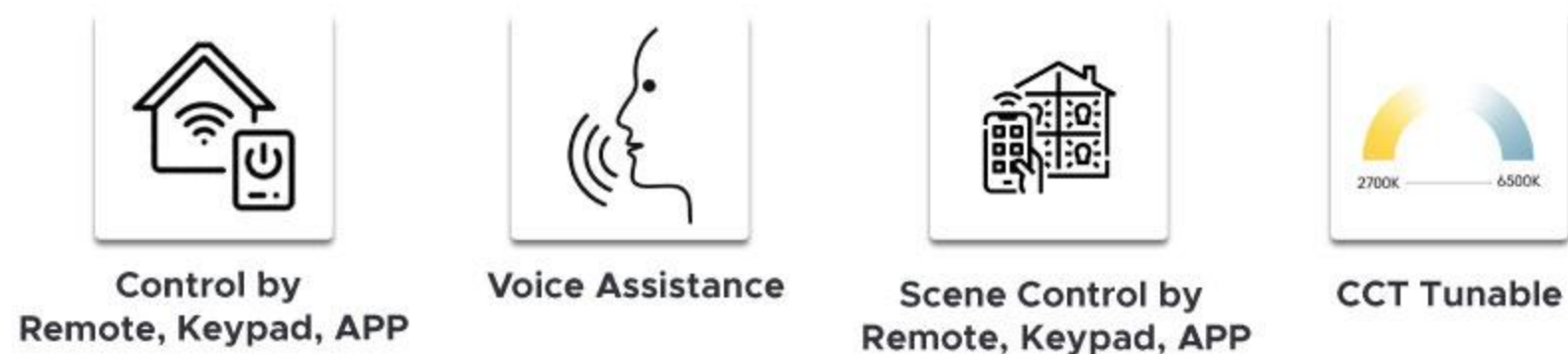

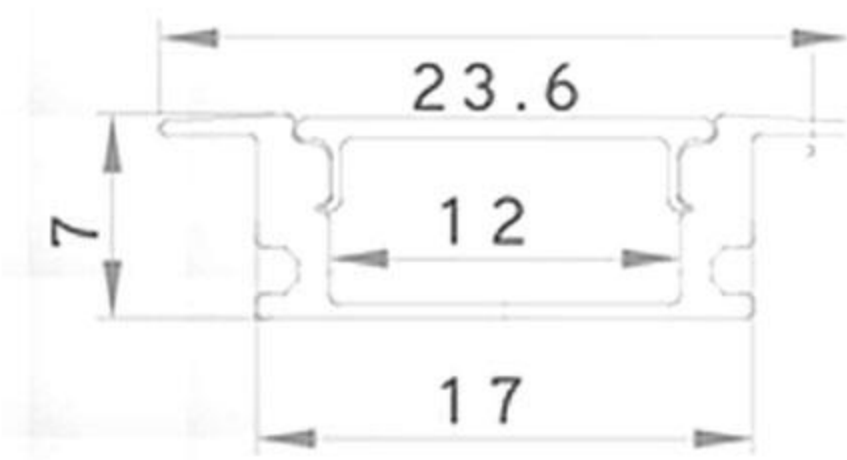

PRODUCT SPECIFICATIONS

Product Type : LED Strip Profile

Diffuser : PMMA

Product Name : 17D Concealed

IP Rating: IP44

Product Code : UHLS-17D-CONCEALED

Mounting Type : Concealed

Color: Silver-Grey

External SMPS Driver Required

DRIVER OPTIONS



SPECIAL ADDITIONAL FEATURES

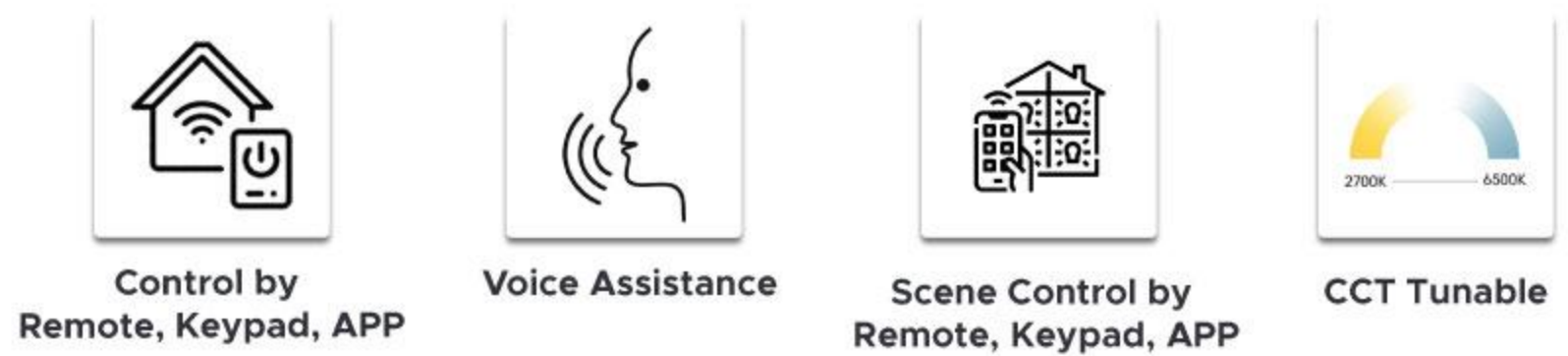

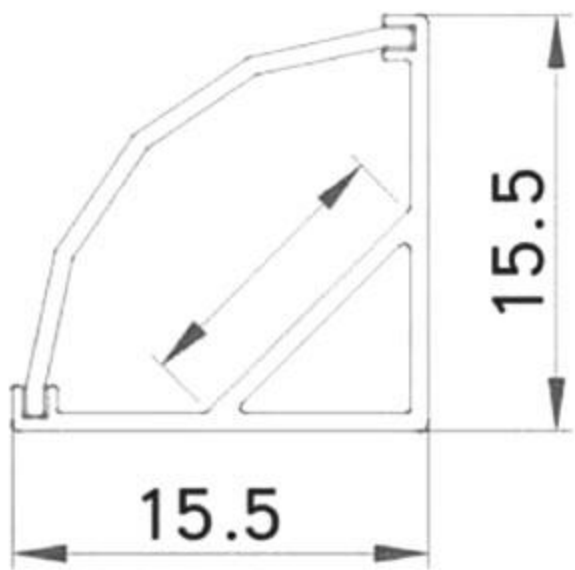

PRODUCT SPECIFICATIONS

Product Type : LED Strip Profile

Diffuser : PMMA

Product Name : 18A Corner

IP Rating: IP 44

Product Code : UHLS-18A-CORNER

Mounting Type: Surface

Color: Silver-Grey

Accessories : End Caps & Back Clamps

DRIVER OPTIONS



SPECIAL ADDITIONAL FEATURES

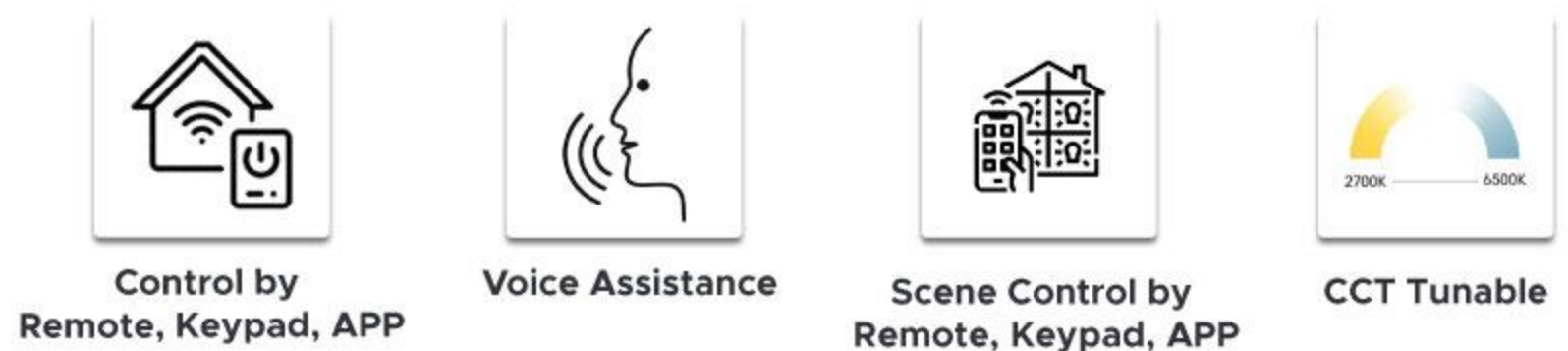

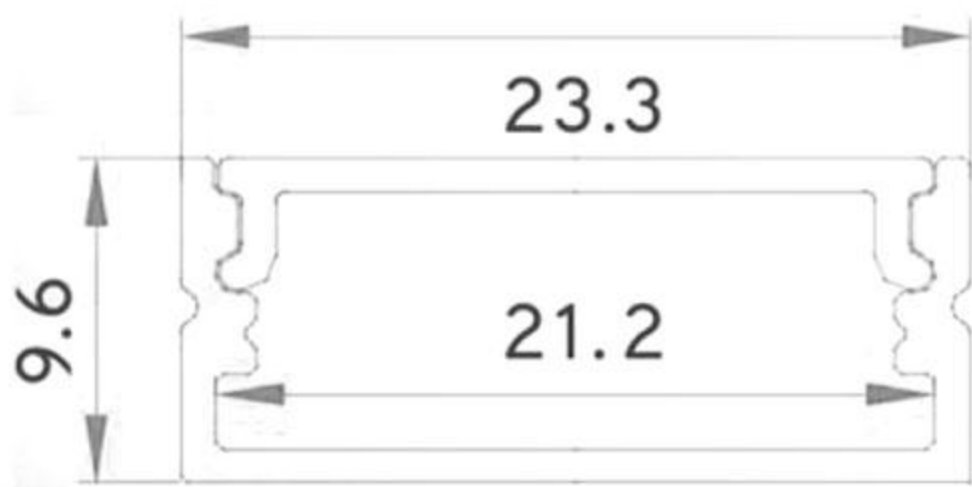

PRODUCT SPECIFICATIONS

Product Type : LED Strip Profile

Product Name : 25A Surface

Product Code : UHLS-25A-SURFACE

Color: Silver-Grey

Diffuser : PMMA

IP Rating: IP 44

Mounting Type: Surface

External SMPS Driver Required

DRIVER OPTIONS



SPECIAL ADDITIONAL FEATURES

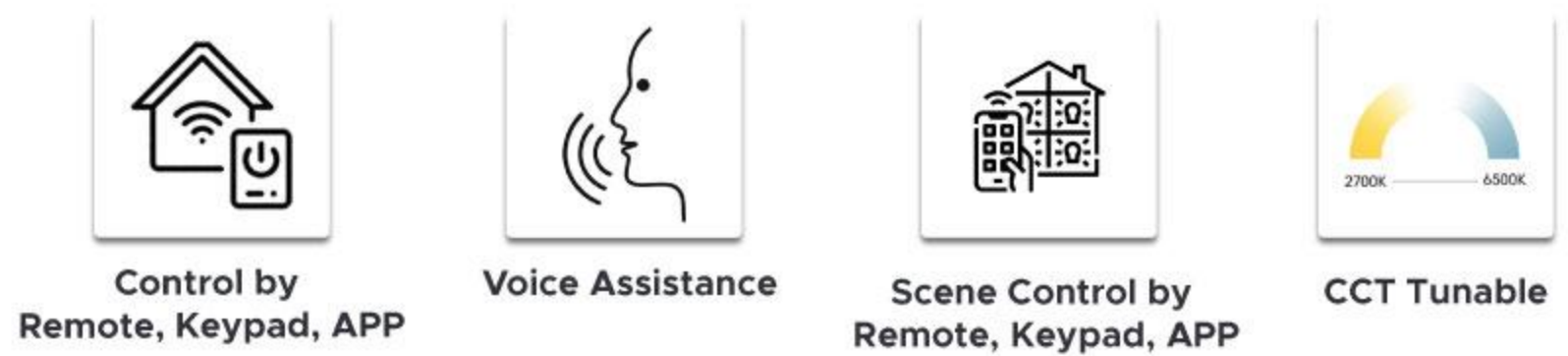

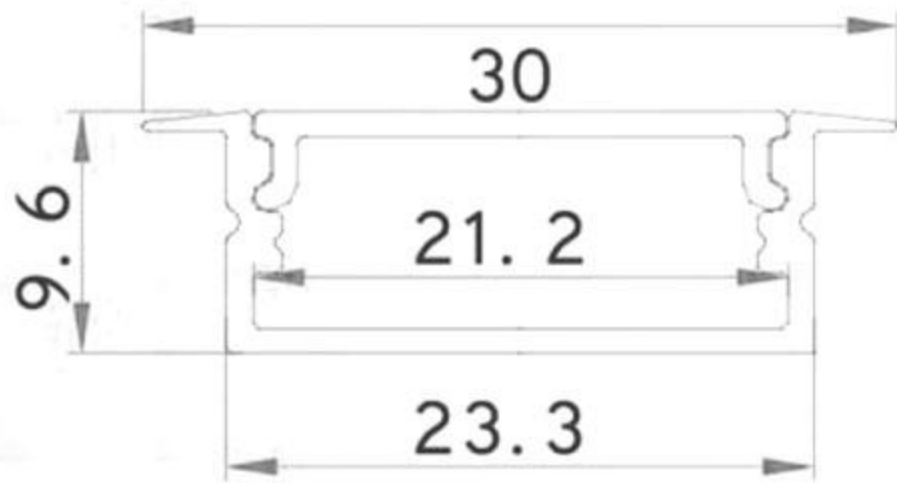

PRODUCT SPECIFICATIONS

Product Type : LED Strip Profile

Diffuser : PMMA

Product Name : 25B Surface

IP Rating: IP 44

Product Code : UHLS-25B-SURFACE

Mounting Type: Surface

Color: Silver-Grey

External SMPS Driver Required

DRIVER OPTIONS



SPECIAL ADDITIONAL FEATURES

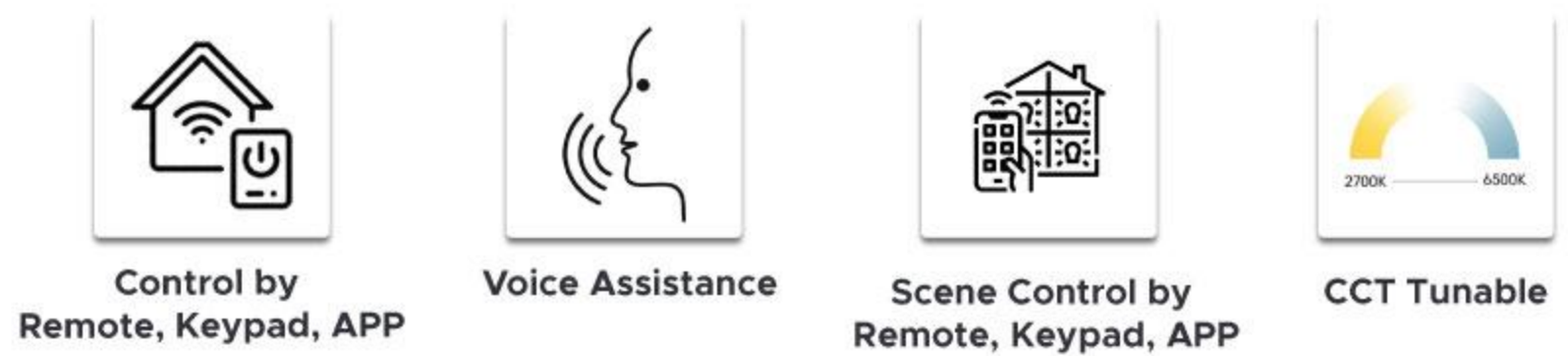

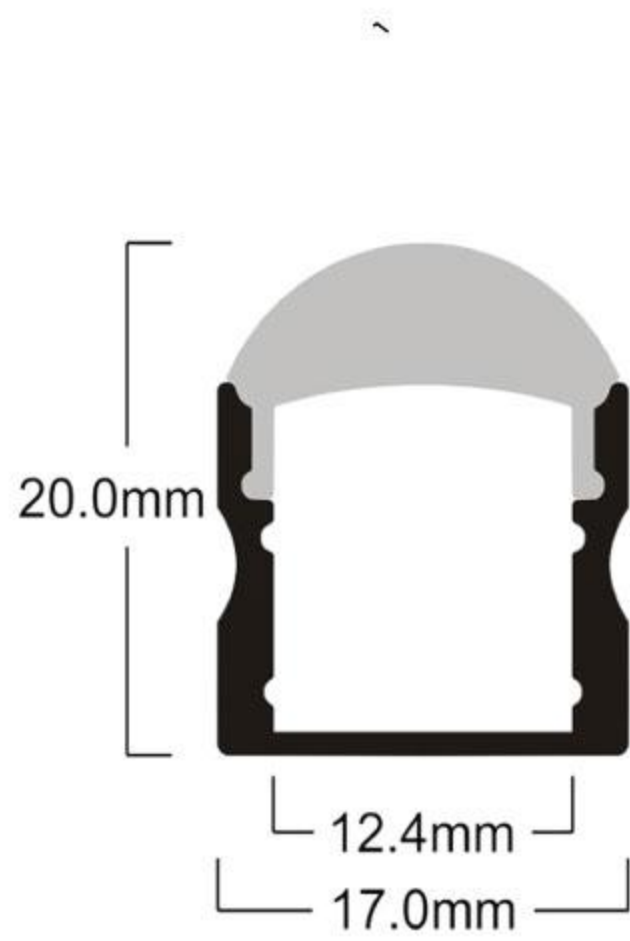

PRODUCT SPECIFICATIONS

Product Type : LED Strip Profile

Material : Aluminium

Product Name : Linear Wall Grazer Profile

Strip PCB Width : 10MM

Product Code : UHLS-LENSE PROFILE

Length: 2M

Color: Anodised Silver

Accessories : Back Clamps

DRIVER OPTIONS



SPECIAL ADDITIONAL FEATURES

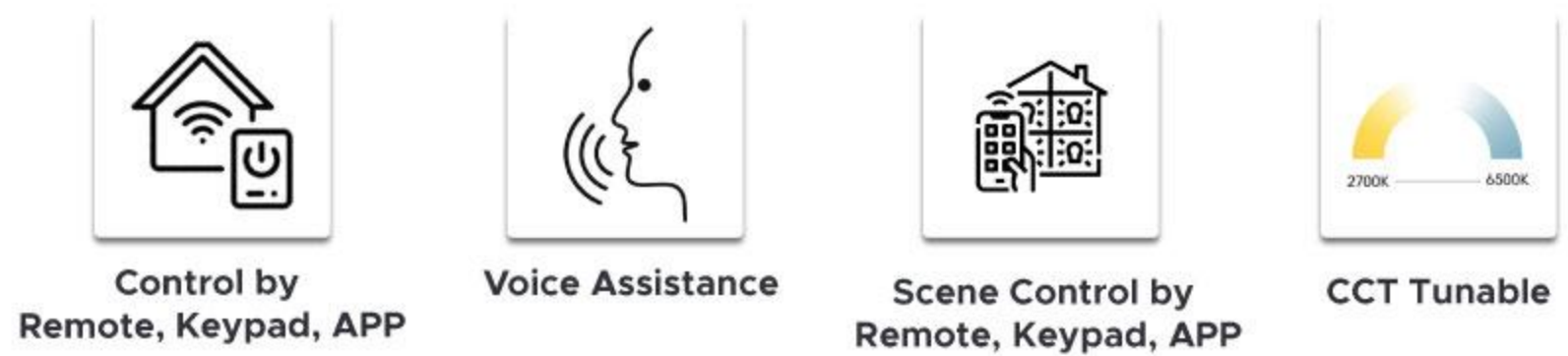

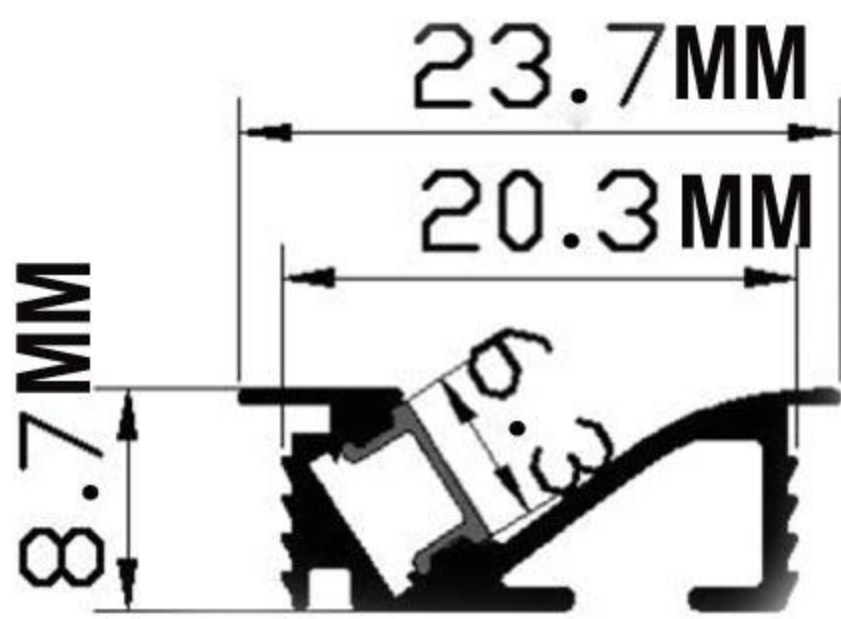
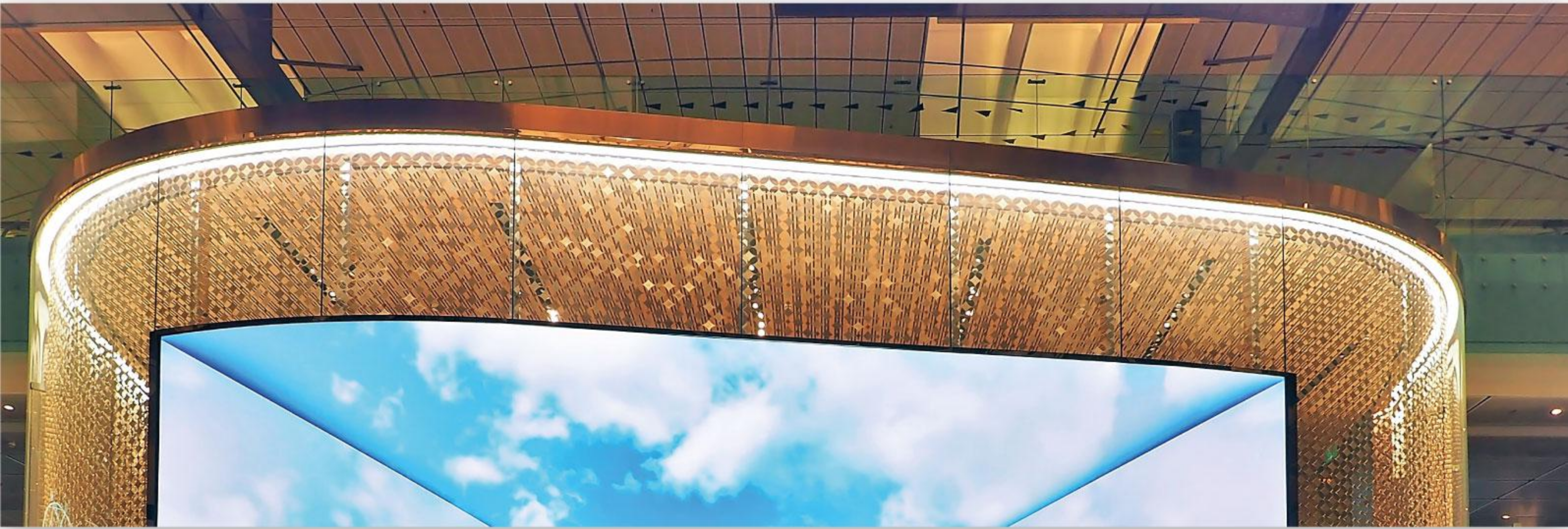

PRODUCT SPECIFICATIONS

Product Type : LED Strip Profile

Product Name : Z-LINEA

Product Code : UHLS-Z-LINEA

Color: Anodised Silver

Material : Aluminium

Strip PCB Width : 5MM

Length: 3M

Accessories : Back Clamps(if required)

DRIVER OPTIONS



SPECIAL ADDITIONAL FEATURES

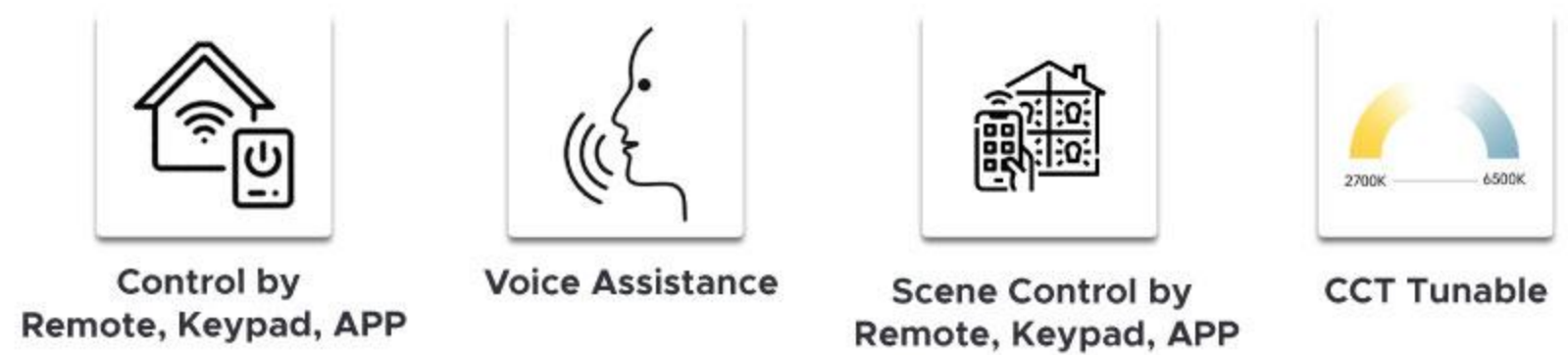

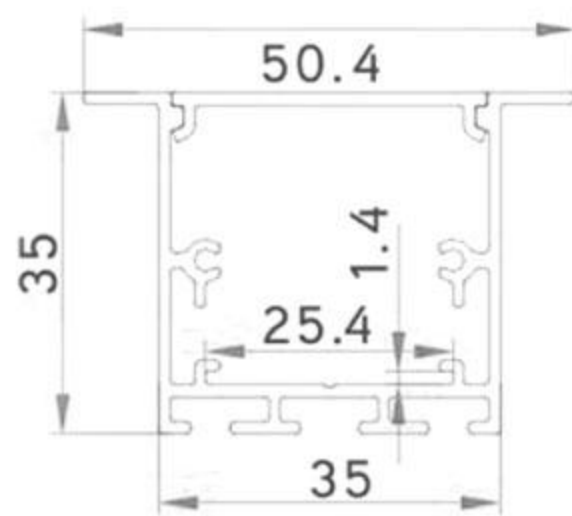
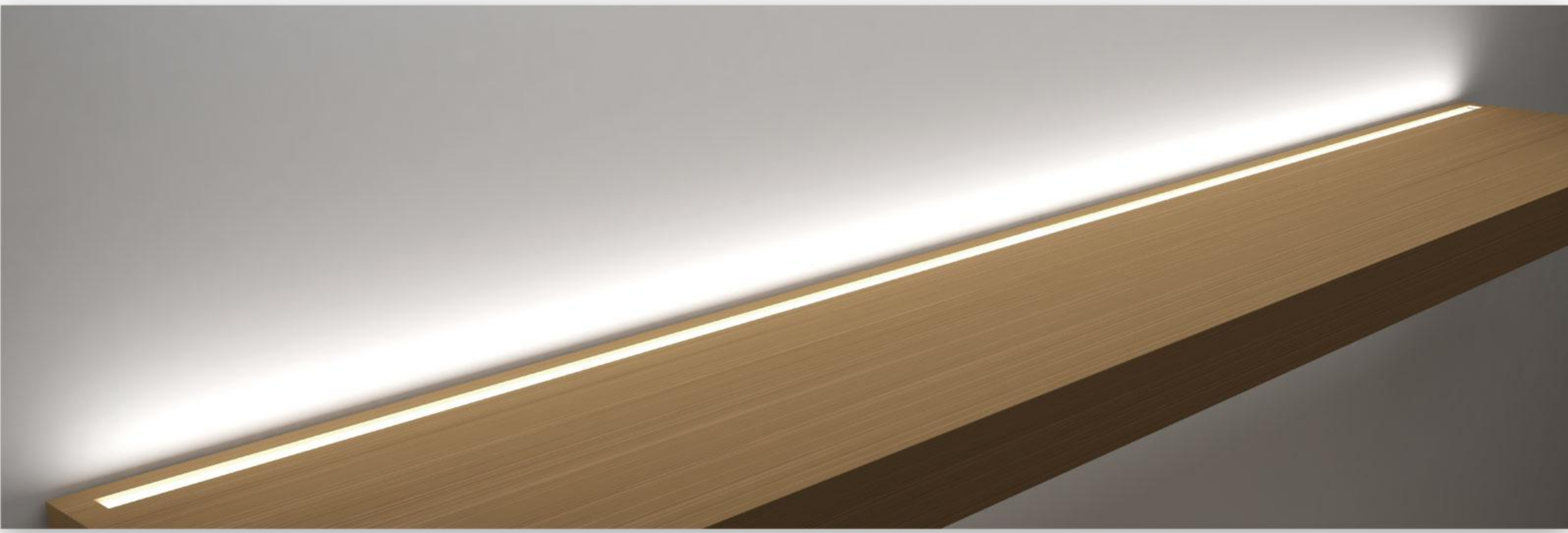

PRODUCT SPECIFICATIONS

Product Type : LED Strip Profile

Diffuser : PMMA

Product Name : 3535B Concealed

IP Rating: IP 44

Product Code : UHLS-3535B-CONCEALED

Mounting Type: Concealed

Color: Silver-Grey

External SMPS Driver Required

DRIVER OPTIONS



SPECIAL ADDITIONAL FEATURES

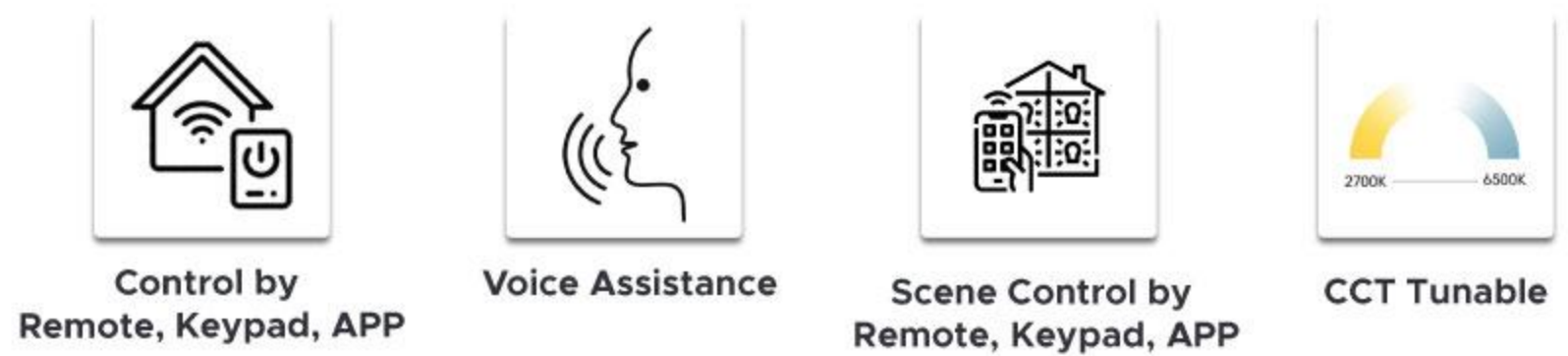

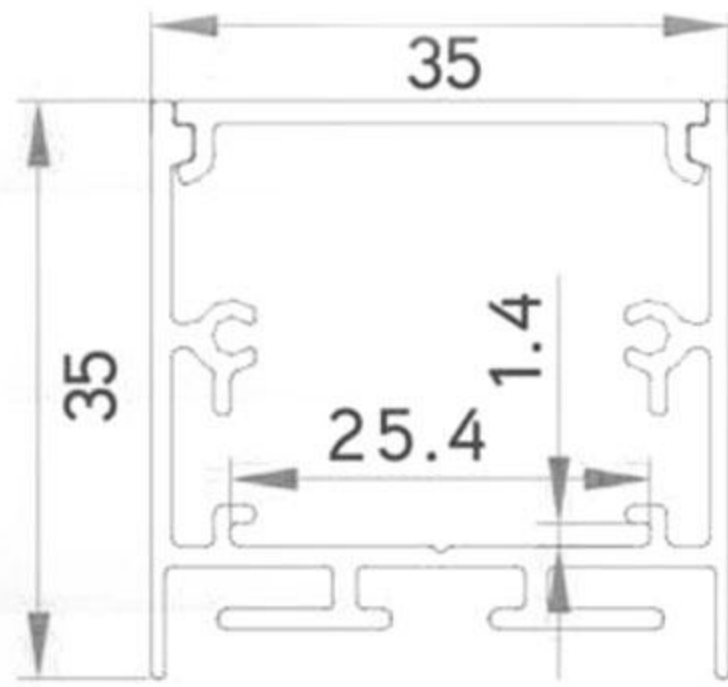

PRODUCT SPECIFICATIONS

Product Type : LED Strip Profile

Diffuser : PMMA

Product Name : 3535A Surface

IP Rating: IP 44

Product Code : UHLS-3535A-SURFACE

Mounting Type: Surface

Color: Silver-Grey

External SMPS Driver Required

DRIVER OPTIONS

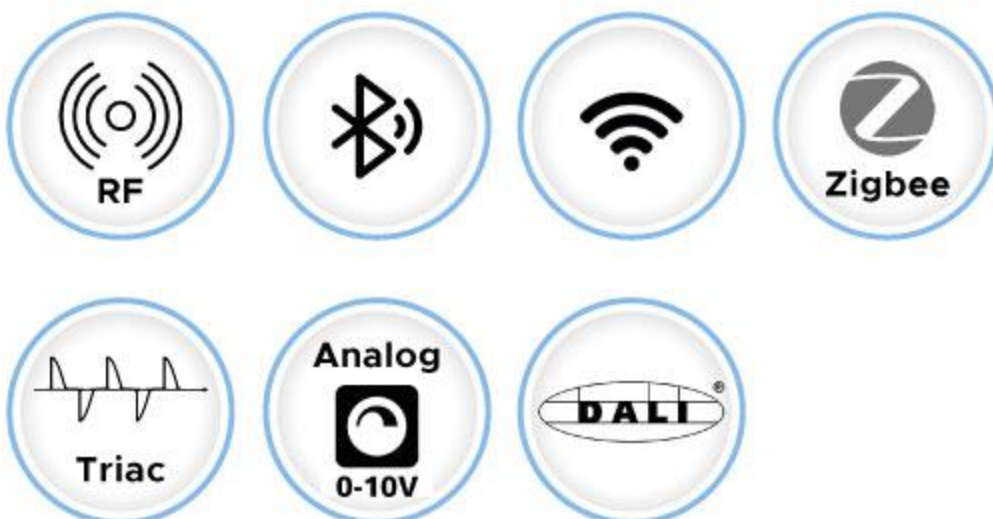

SPECIAL ADDITIONAL FEATURES

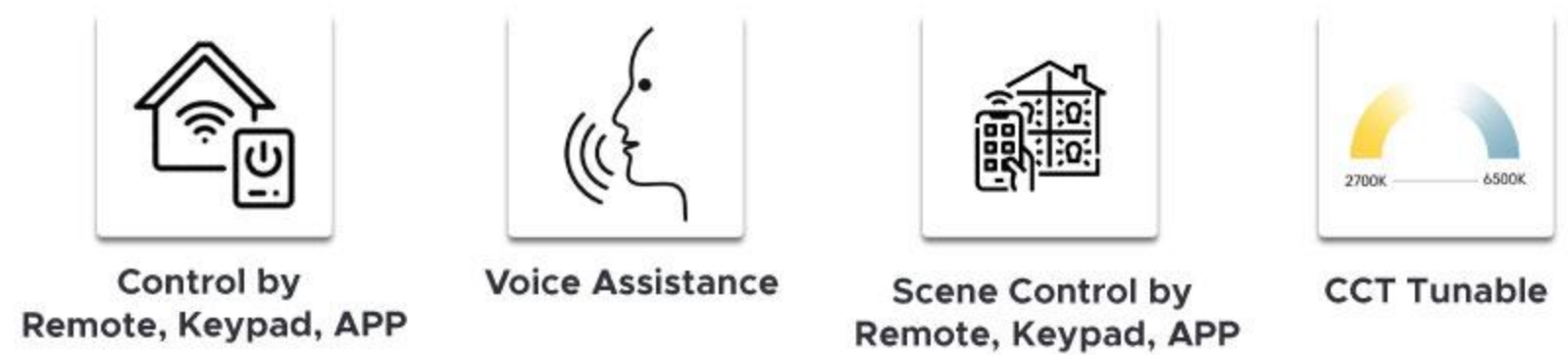

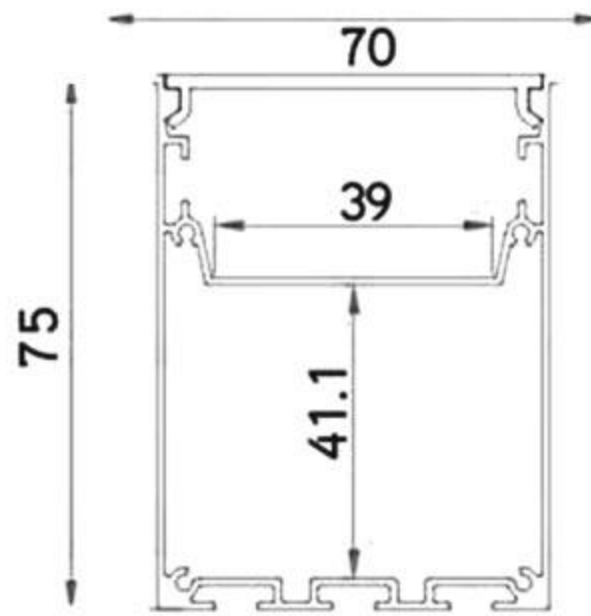

PRODUCT SPECIFICATIONS

Product Type : LED Strip Profile

Product Name : 5575A Surface

Product Code : UHLS-5575A-SURFACE

Color: Silver-Grey

Diffuser : PMMA

IP Rating: IP 44

Mounting Type: Surface

External SMPS Driver Required

DRIVER OPTIONS



SPECIAL ADDITIONAL FEATURES

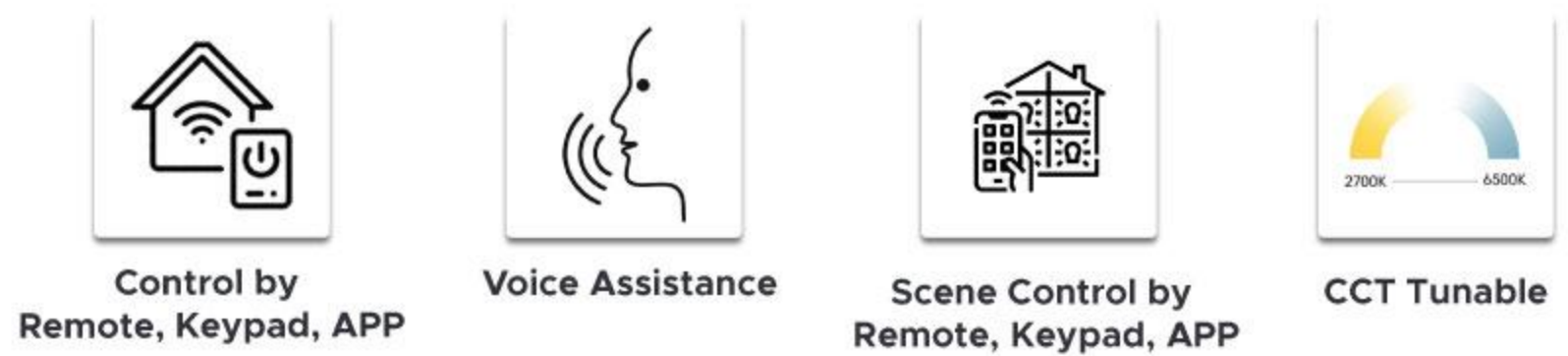

THINK LED, THINK UNISER

UNISER

INDUSTRIES PVT. LTD.

Solar Power | LED Lighting | Automation

To place your order, please contact us

HELPDESK DETAILS:

414, Lotus House, 33-A, V Thackersey Marg, New Marine Lines,
Mumbai-400020, India

+91-22-22000515 | 35114465  +91 9867625686

 sales@uniserledlights.com | www.uniserledlights.com